

CARPENTRY

Carpentry is the process of shaping Timber, using hand tools. The products produced are used in building construction, such as doors and windows, furniture manufacturing, patterns for moulding in foundries, etc. Carpentry work mainly involves the joining together of wooden pieces and finishing the surfaces after shaping them. Hence, the term joining is also used commonly for carpentry. A student studying the fundamentals of wood working has to know about timber and other carpentry materials, wood working tools, carpentry operations and the method of making common types of joints.

Materials Used in Carpentry:

Basic materials used in carpentry shop are timber and plywood. Auxiliary materials used are nails, screws, adhesives, paints, varnishes, etc.

Timber:

Timber is the name given to wood obtained from exogenous (outward growing) trees. In these trees, the growth is outward from the centre, by adding almost concentric layers of fresh wood every year known as annual rings. After the full growth, these trees are cut and sawed to convert into rectangular sections of various sizes for engineering purposes.

Timber is available in market in various shapes and size. The common shapes and sizes are given below:

1. Log: This is the trunk of the tree which is free from branches.
2. Balk: This is the log after sawing roughly to square cross section.
3. Deal: This is the log after sawing into rectangular cross section of width about 225 mm and thickness up to 100 mm.
4. Plank: This is the timber piece having width more than 275 mm and thickness 50 to 150 mm.
5. Board: This is the timber piece below 50 mm in thickness and above 125 mm in width,
6. Batten: This is the timber piece below 175 mm in width and thickness between 30 mm to 50 mm in thickness.
7. Scantlings: These are timber pieces of various assorted and nonstandard sizes other than the types given above.

Classification of Wood:

The timber used for commercial purposes can be divided into two classes as soft wood and hard wood

Soft wood

A soft wood is light in weight and light colored. They may have distinct annual rings but the medullary rays (radial lines) are not visible and the color of the *sap wood* (outer layers) is not distinctive from the heart wood (inner layers). These woods cannot resist stresses developed across their fibers; hence, not suitable for wood working.

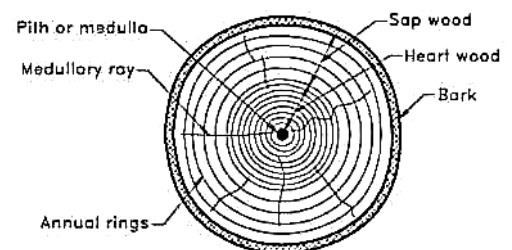

Fig. 1 Hard Wood

Hard wood

In this type of wood the annual rings are compact and thin and the medullary rays (radial lines) are visible in most cases (Figure 1). Hard woods are nearly equally strong both along and across the fibers. Hard wood is the material used for wood working

Classification of timber

According to the manner of growth of trees, timber can be classified as

- i) Exogenous or out ward growing
- ii) Endogenous or in ward growing

In exogenous trees the growth take place from the centre by the addition of concentric layers of fresh wood every year, known as annual rings. These varieties of trees are suitable for building and other engineering uses the exogenous trees are again classified as

- a) Conifers or ever green trees
- b) Deciduous or broad leaf trees

The conifer gives soft woods and the deciduous gives hard wood common example of hard wood are Sal, teak, rose wood, sandal, shisham, oak beach, ash ebony, mango, neem, babool, etc., soft wood include kail pine, deodar chair, walnut seemal etc.

ii) Endogenous or in ward growing timber

These trees grow in wards i.e. every fresh layer of sap wood is added inside instead of outside cane, bamboo, coconut

Seasoning

Seasoning of wood carried out for removing the sap and reducing the moisture content the presence of sap and moisture will render the wood unsuitable for engineering works due to uneven shrinkage, crack, warping and decay.

Different methods of seasoning

1. Air seasoning or Natural seasoning
2. Water seasoning
3. Electrical seasoning
4. Kiln seasoning

Ply wood

Thick sheet formed by pasting veneers of wood is called ply. Three or more plys joined by glues is called plywood. The grains of adjacent layers are kept at right angle to each other in order to get better strengthening both directions the outer layer are called facing plys and good hard wood veneers are used for this inner ones are called core plys and low quality wood is used for this the ply wood is made by either cold pressing or hot pressing.

Tools for wood working

The principle hand tools used in a carpentry workshop can be classified into

- i) Marking and measuring tool
- ii) Cutting tool
- iii) Planning tool
- iv) Boring tool
- v) Striking tool
- vi) Holding tool

Marking and measuring tool

- a) Rules: Rules are used for measuring dimensions. For measuring and setting out dimensions various types of rules are used in carpentry shop. Steel Rule- Stainless Steel Rule of length 30cm and 60cm.

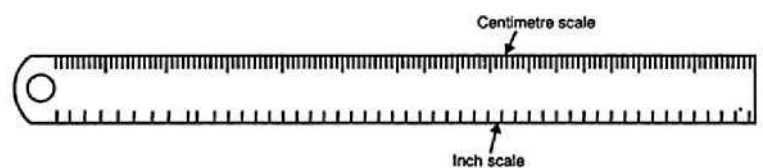

Fig. 2 Rule

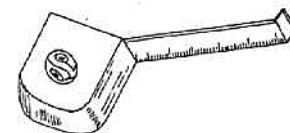

Fig. 3 Measuring Steel Tape

Flexible Measuring Rule- for measuring large dimensions as well as curved or angular surface dimensions.

- b) Straight Edge and Squares: This is a machined flat piece wood or metal having perfectly straight and

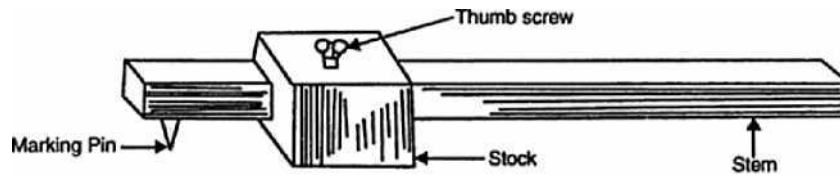

Fig. 4 Marking Gauge

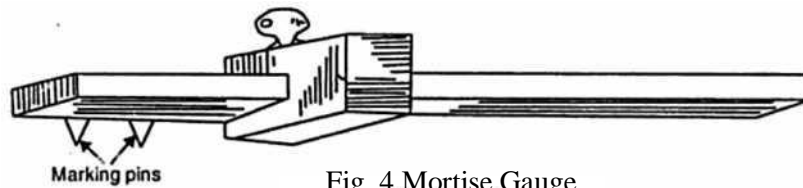

Fig. 4 Mortise Gauge

parallel edges.

- c) Steel Tape: It is used for large dimensions, such as marking on boards and checking the overall dimensions of the work.
- d) Gauges: Gauges are used to mark lines parallel to the edges of a wooden piece. It mainly consists of a wooden stem sliding inside a wooden stock. The stem carries a steel point for marking lines. The stock position on the stem can be varied and fixed rigidly by tightening the thumb screw. To mark a line parallel to an edge the gauge stock is held freely against the edge and pushed along it, pressing the steel points to the surface.
- e) Try Square: Try square consists of rectangular steel blade fixed rigidly to cast iron stock. The length of blade varies from 150mm to 300mm.
- f) Marking Knife or Scriber: Marking Knives are used to convert the pencil lines drawn on the wooden surface into deep scratch lines on the surface. They are made of steel with a sharp point at one end and flat blade at the other end.
- g) Bevel Square: It is also called as sliding level. It is an adjustable try-square for measuring/marketing angles between 0° and 180° .

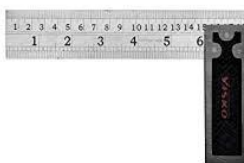

Fig. 5 Try Square



Fig. 6 Marking Knife

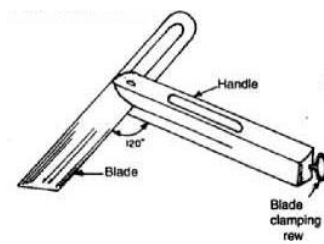

Fig. 7 Bevel Square

Holding tools

- a) Work Bench: This is a table of having size and raised construction made of hard wood. The size ranges from 50- 80 cm in length and about 90cm in width. Two or four carpenters can work at a time on the work bench.

b) Carpenters Bench Vice: It consists of jaw fixed on the table side and movable jaw kept in position by means of screw and handle. The body of vice is made of cast iron or steel. The jaws are lined with hard wood which can be removed when it is damaged. The screw moves inside the fixed half nut which can be engaged or disengaged by operating the lever. This is made up of a bar of steel. The work is clamped between jaws by rotating the screw using the handle. It is used for clamping glued pieces or holding the work piece of larger size together for various operations.

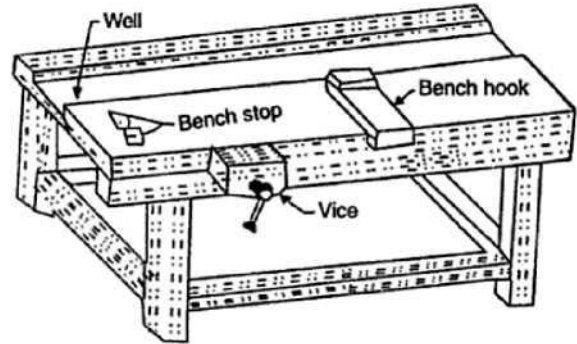

Fig. 8 Carpenters' Work Bench with Bench Vice

c) C Clamp: The clamp of the shape of letter C or G is used to clamp short pieces together as the bar clamp. These clamps are available in sizes varying from 70 mm to 800 mm. It is used for holding the planks after gluing

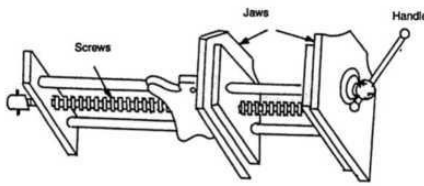

Fig. 9 Carpenters' Bench Vice

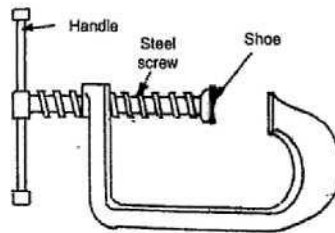

Fig. 10 C-Clamp

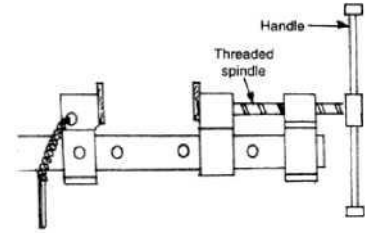

Fig. 11 Bar or T-Cramp

d) Bar or T-cramp: it consists of a steel bar fitted with a threaded spindle and an adjustable shoe. It is used for holding the glued pieces tightly or holding firmly two or more unglued pieces for fitting dowels or doing other operations on them in assembled position.

Cutting tools

a) Saws: Saw is a cutting tool which has teeth on one edge and cutting is affected by reciprocating motion of the edge relative to the work piece. Cutting occurs during the forward motion; such a saw is called push type saw; the cutting occurs during the backward motion.

- i. Hand Saw- This saw is used for short straight cuts. It has a blade of 25-40cm length 610cm width. The number of teeth per cm length ranges from 3-5.
- ii. Tenon Saw (Back Saw)- It has a parallel blade of 25-40cm length and 6-10cm width. The number of teeth per cm length ranges from 5-8.

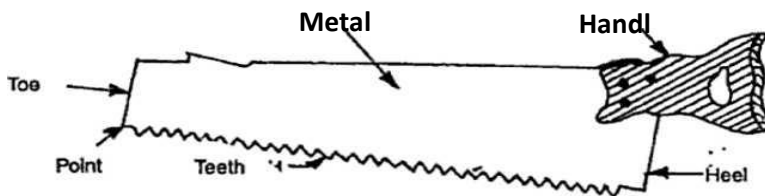

Fig. 12 Hand Saw

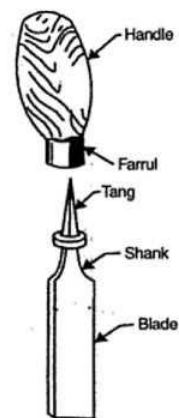

Fig. 13 Parts of a Chisel

b) Chisels: The common type of chisels used is briefly explained below.

- i. Firmer Chisels- they are most common and general-purpose chisel used by a carpenter. They have flat blade of 15-50mm width and 125mm

length.

- ii. Dove Tail Chisel (beveled edge firmer chisel) - These chisels are used for fine and delicate works as well as for cutting corners.
- iii. Mortise chisel - These chisels are used for heavy and deep cut to remove large quantity of wood. These chisels have width of about 15mm but the blade thickness may range from 6 to 15mm.

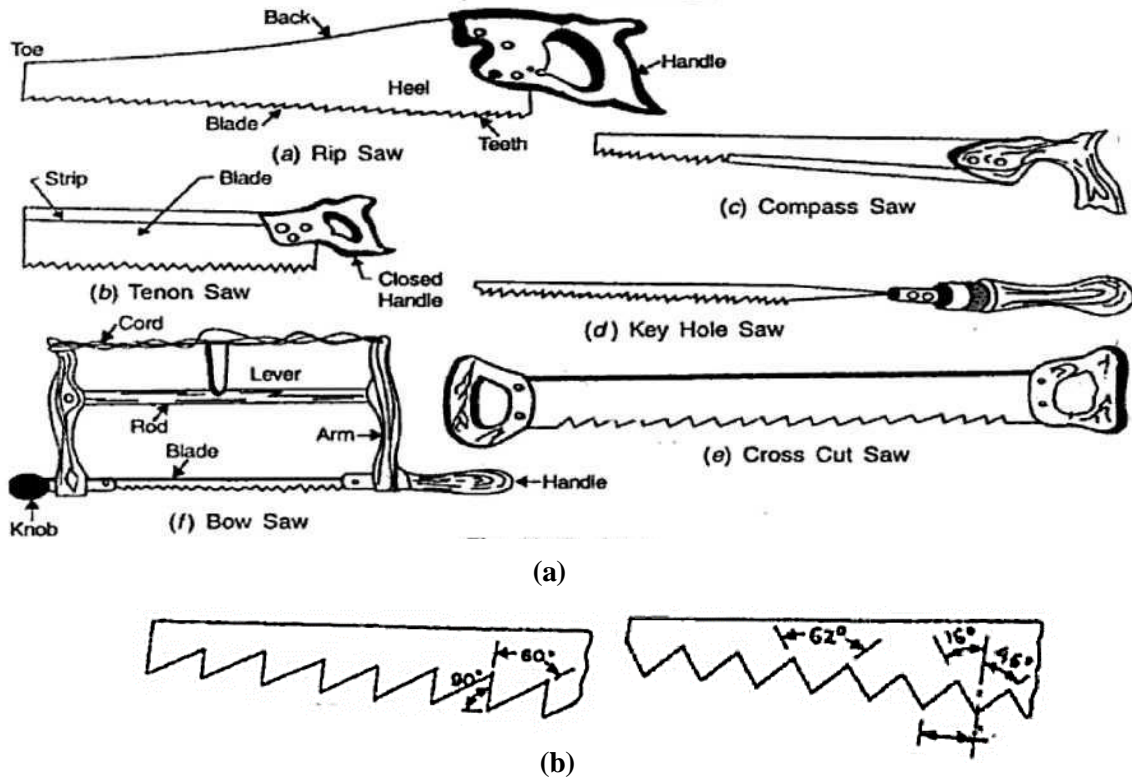
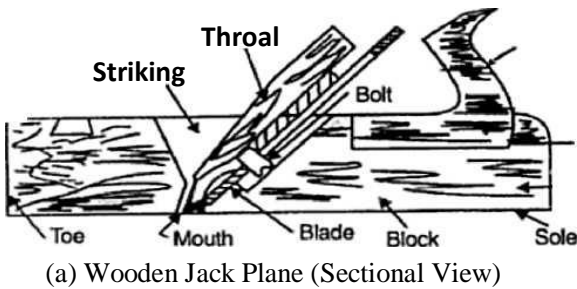

Fig. 14(a) Types of Saws; (b) Tooth Profiles

Planing Tools: Planing tool is used to smoothen the wooden surfaces.

a) Wooden jack plane: This is the most commonly used plane in carpentry shop. The main part of a wooden jack plane is a wooden block called sole, in which steel blade having knife edge is fixed at an angle with the help of wooden edge. The angle of the blade is kept about 45 ° to bottom surface of the blade.

b) Metal Jack Plane: It serves the same purpose as the wooden jack plane but facilitates a smoother operations and better finish. The body of a metal jack plane is made from a grey iron casting with the side and sole machined and ground to better finish.



(a) Wooden Jack Plane (Sectional View)

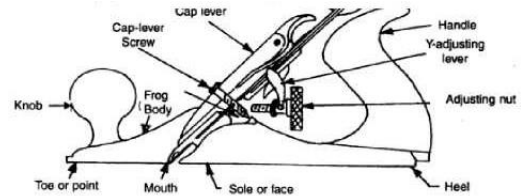

(b) Iron Jack Plane

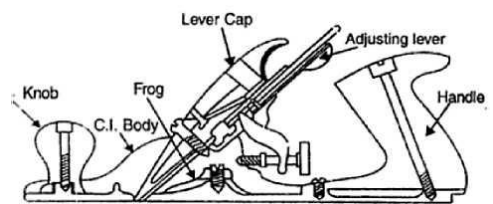

(c) Iron Jack Plane (Sectional View)

Fig. 15 Planing Tools

Drilling and Boring Tools

- a) Bradawl: It is a hand operated tool, used to bore small holes for starting a screw or large nail.
- b) Carpenters brace: it is used for rotating auger bits, twist drills, etc. to produce holes in wood. In some designs, braces are made with ratchet device.
- c) Auger bit: it is the most common tool used for making holes in wood. During drilling, the lead screw of the bit guides into the wood, necessitating only moderate pressure on the brace. The helical flutes on the surface carry the chips to the outer surface.
- d) Hand drill: carpenter's brace is used to make relatively large size holes; whereas hand drill is used for drilling small holes. A straight shank drill is used with this tool. It is small, light in weight and may be conveniently used than the brace. The drill bit is clamped in the chuck at its end and is rotated by a handle attached to gear and pinion arrangement.
- e) Gimlet: it has cutting edges like a twist drill. It is used for drilling large diameter holes with the hand pressure.

Striking Tools

- a) Mallet: This is wooden headed hammer of round or rectangular section. The striking face is made flat. Mallet is used for the cutting tools and has wooden handle.
- b) Claw Hammer: This is a hammer having steel head and wooden handle. The flat face of the head is used for striking and claw portion for extracting nails out of the wood.

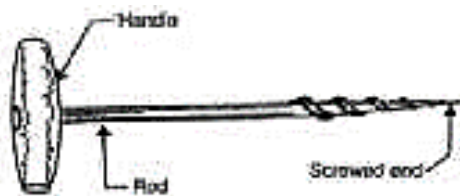

Fig. 16 Gimlet

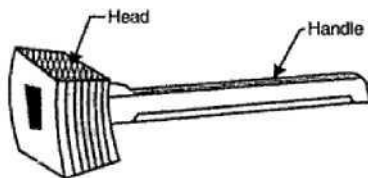

Fig. 18 Mallet

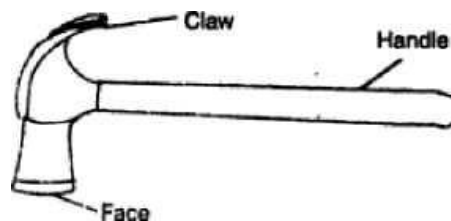

Fig. 19 Claw Hammer

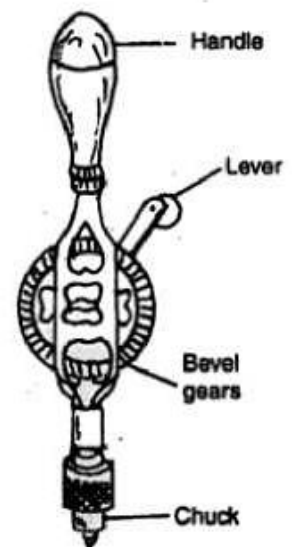

Fig. 17 Hand Drill

EXPERIMENT – 1

DOVETAIL LAP JOINT

AIM: To make a dovetail lap joint.

Materials Required: Teak wood (30mm x 150mm x 50mm)

Tools and Equipment Used:

1. Steel rule
2. Try square
3. Marking gauge
4. Rip saw
5. Tenon saw
6. Mortise chisel
7. Mallet
8. Jack plane
9. Wood rasp file

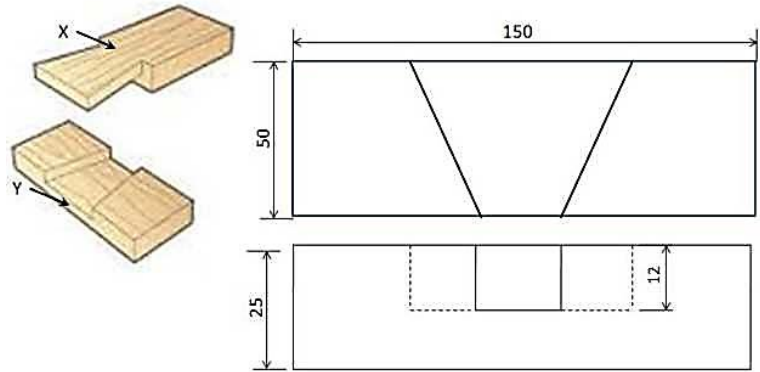

Operations to be carried out:

1. Planning
2. Marking
3. Sawing
4. Chiseling
5. Finishing

Procedure:

1. The wooden pieces are made into two halves and are checked for dimensions.
2. One side of pieces is planned with jack plane and for straightness.
3. An adjacent side is planned and checked for squareness with a try square.
4. Marking gauge is set and lines are marked at 40-50 mm to make the thickness and width according to given figure.
5. The excess material is planned to correct size.
6. Using tenon saw, the portions to be removed are cut in both the pieces
7. The excess material in X is chiseled with mortise chisel.
8. The excess material in Y is chiseled to suit X
9. The end of both the pieces is chiseled to exact lengths.

Precautions:

1. Wood should be free from moisture
2. Marking is done without parallax error
3. Care should be taken while chiseling
4. Matching of X and Y pieces should be tight.

Result: The dovetail lap joint is made successfully.

EXPERIMENT – 2

CROSS HALF LAP JOINT

AIM: To make a cross half lap joint.

Materials Required: Teak wood (30mm x150mm x 50mm)

Tools and Equipment Used:

1. Steel rule
2. Try square
3. Marking gauge
4. Rip saw
5. Tenon saw
6. Mortise chisel
7. Mallet
8. Jack plane
9. Wood rasp file

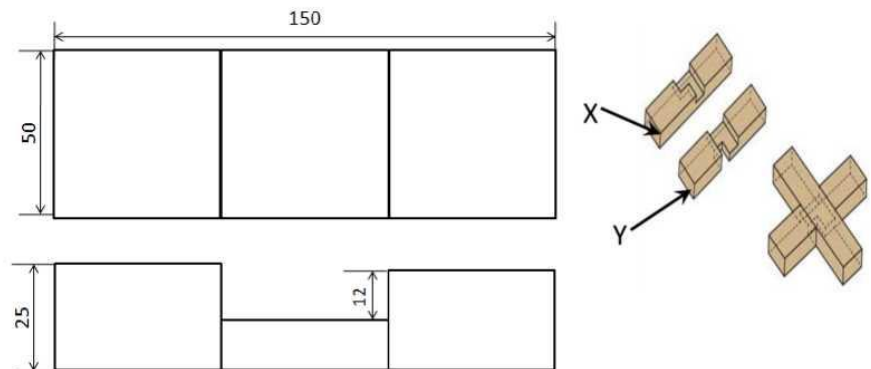

Operations to be carried out:

1. Planning
2. Marking
3. Sawing
4. Chiseling
5. Finishing

Procedure:

1. The wooden pieces are made into two halves and are checked for dimensions.
2. One side of pieces is planned with jack plane and for straightness.
3. An adjacent side is planned and checked for squareness with a try square.
4. Marking gauge is set and lines are marked at 40-50 mm to make the thickness and width according to given figure
5. The excess material is planned to correct size.
6. Using tenon saw, the portions to be removed are cut in both the pieces
7. The excess material in X is chiseled with mortise chisel.
8. The excess material in Y is chiseled to suit X
9. The end of both the pieces is chiseled to exact lengths.

Precautions:

1. Reamer should be free from moisture
2. Marking is done without parallax error
3. Care should be taken while chiseling
4. Matching of x and y pieces should be tight.

Result: The cross-half lap joint is made successfully.

FITTING

The term fitting, is related to assembly of parts, after bringing the dimension or shape to the required size or form, in order to secure the necessary fit. The operations required for the same are usually carried out on a work bench, hence the term bench work is also added with the name fitting.

The bench work and fitting plays an important role in engineering. Although in today's industries most of the work is done by automatic machines which produces the jobs with good accuracy but still it (job) requires some hand operations called fitting operations. The person working in the fitting shop is called fitter

FITTING TOOLS:

Fitting shop tools are classified as below:

- Work Holding Devices/ Clamping Tools.
- Measuring and Marking Tools.
- Cutting Tools.
- Striking Tools.
- Drilling Tools.
- Threading Tools.

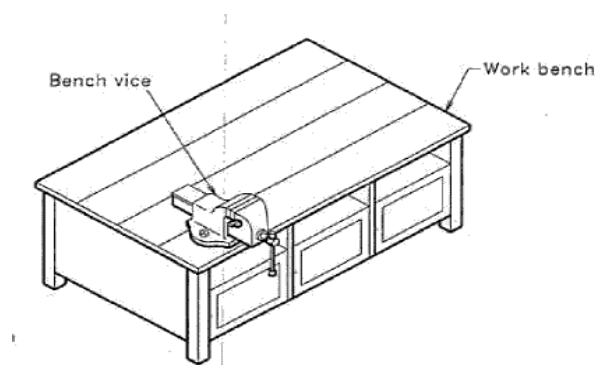

Fig.1 Work Bench

WORK HOLDING DEVICES /CLAMPING TOOLS:

- **Work Bench**

A fitting process can be done at various places, but most of the important operations of fitting are generally carried out on a table called work bench.

The work bench is a strong, heavy and rigid table made up of hard wood.

Fig. 1 Work Bench

The size of the work bench required is about 150 to 180 cm length, nearly 90 cm width and approximately 76 to 84 cm height.

- **BENCH VICE:**

It is firmly fixed to the bench with the help of nuts and bolts. It consists of a cast Iron body and cast iron jaws. Two jaw plates are fitted on both the jaws. The holding surface of the jaw plates is knurled in order to increase the gripping. Jaw plates are made up of carbon steel and are wear resistant. One jaw is fixed to the body and the second slides on a square threaded screw with the help of a handle.

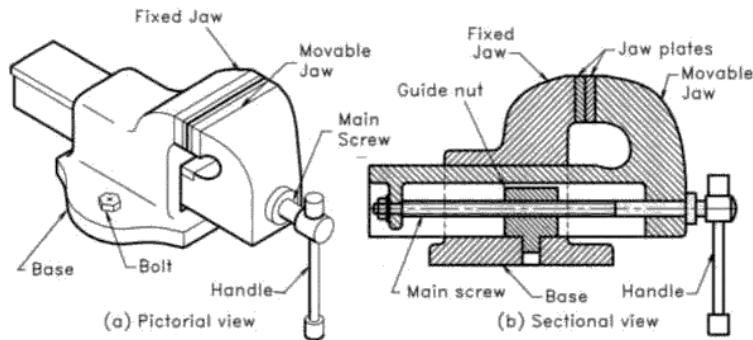

Fig. 2 Bench Vice

The jaws are opened upto required length; job is placed in the two jaws and is fully tightened with the help of handle. Handle is used to move the movable jaw

- **V Block**

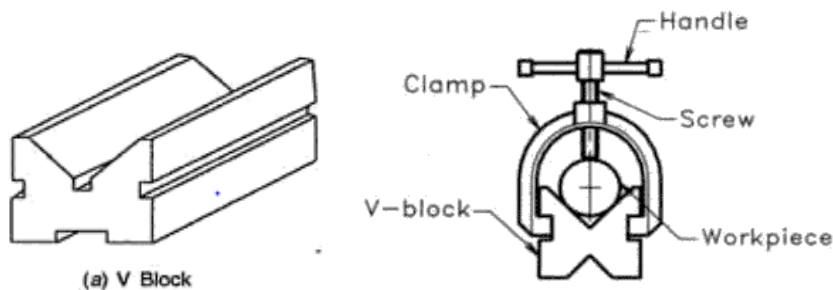

Fig. 3 V Block

In V Block, V grooves are provided to hold the round objects longitudinally. The screw of the clamp applies the holding pressure. When the handle is rotated there is movement in the screw.

- **Steel Rule**

These are made up of stainless steel and are available in many sizes ranging from 1/2 ft. to 2 ft. These are marked in inches or millimeters. All the faces are machined true. The edges of steel rule should be protected from rough handling.

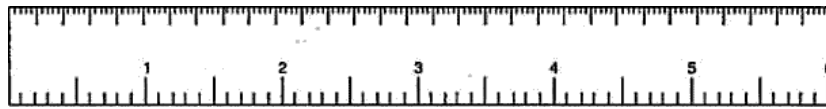

Fig. 4 Steel Rules

• **Calipers**

These are generally used to measure the inside or outside diameters. Different types are:

- Outside Caliper: It is used to measure the outside dimensions.
- Inside Caliper: It is used to measure the inside dimensions.
- Spring Caliper: Spring is provided to apply the pressure and lock nut is provided to lock any desired position.

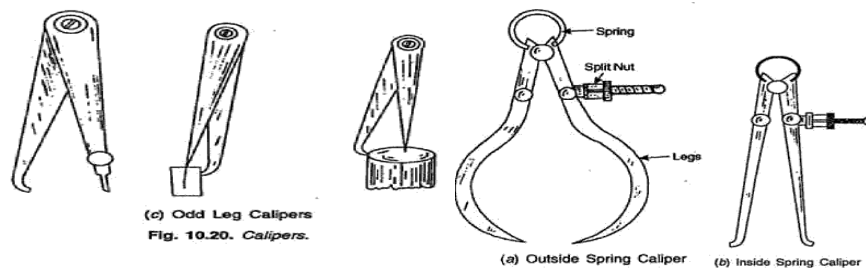

Fig. 5 various types of Calipers

- Hermaphrodite, Jenny or Oddleg Caliper: One leg is bent at the tip inwardly and the other has a straight pointed end. It is used to scribe lines parallel to the straight edges.

Vernier Caliper:

It is used for measuring the outer dimensions of round, flat, square components and also the inner size of the holes and bore. A narrow blade is used to measure the depth of bar slots etc. The reading accuracy in metric system is 0.02 mm and British system it is 0.001". It is made of stainless steel.

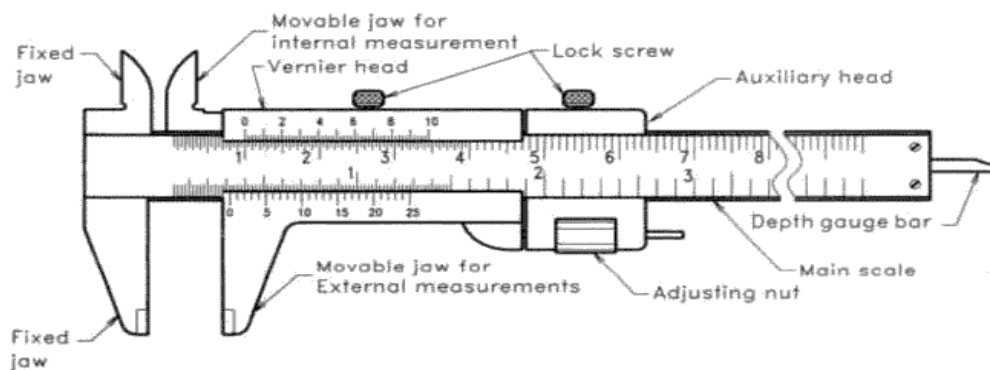

Fig. 6 Vernier Calipers

III. MARKING TOOLS:

- **Surface Plate**

It is used for testing the flatness, trueness of the surfaces. It is made up of cast iron or graphite. Its upper face is planned to form a very smooth surface. It is also used in scribing work. While not in use; it should be covered with a wooden cover.

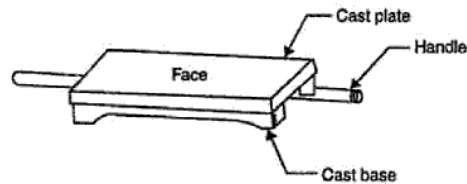

Fig. 7 Surface Plate

- **Angle Plate**

It is made up of cast iron in different sizes; it has two planed surfaces at right angles to each other and has various slots in each surface to hold the work by means of bolts and clamps. Never do hammering on the angle plate to fasten (loosen) the nuts and bolts.

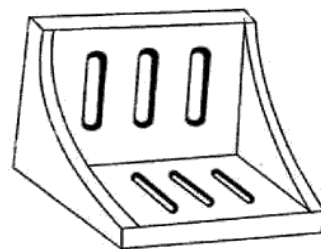

Fig. 8 Angle Plate

- **Scriber and Surface Gauge**

It consists of a cast iron base on the center of which a steel rod is fixed vertically. Scriber is made up of high carbon steel and is hardened from the front edge. It is used for locating the centres of round bars or for marking of the lines.

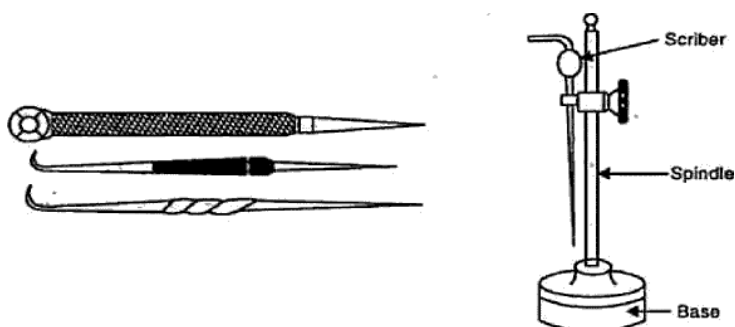

Fig. 9 Scriber and Surface Gauge

- **Punches**

Punches are used for marking purposes. Dot punches are used for marking dotted line and centre punch is used to mark the centre of hole before drilling. Punches are made up of high carbon steel or high speed steels. One end is sharpened. Hammering is done on the second end while working. For dot punch, angle of the punching end is 60 degree while in centre punch; angle of punching end is 90 degree.



(a) Dot Punch

(b) Centre Punch

Fig. 10 Punches

- **Try Square**

It is used for checking squareness of two surfaces. It consists of a blade made up of steel, which is attached to a base at 90 degree. The base is made up of cast iron or steel. It is also used to mark the right angles and measuring straightness of surfaces. Never use try square as a hammer.

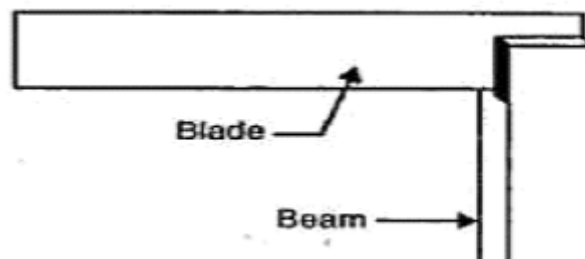
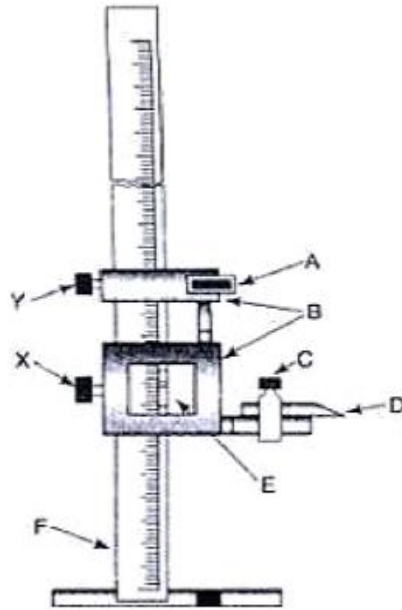

Fig. 11 Try Square

- **Vernier Height gauge**

A Vernier height gauge consists of a heavy base, a graduated beam, a sliding head with Vernier sliding jaws holding the scribe and a fine adjustment clamp. It is similar to large Vernier calipers in construction, except that it consists of a heavy base which allows the gauge to stand upright instead of a fixed jaw in a Vernier. The movable jaw of Vernier height gauge consists of a projection or extension which is levelled to sharp edge for scribing lines at any required height.



- | | |
|-----------------------|--------------------|
| A-Fine | B-Vernier slide |
| C-Scriber clamp screw | D- Scriber |
| E – Vernier Scale | F - Main Scale |
| G - Base | X, Y - Lock Screws |

Fig. 12 Vernier Height Gauge

METHOD OF MARKING

Marking means setting out dimensions with the help of a working drawing or directly transferring them from a similar part.

The procedure of marking is as follows:

- The surface to be marked is coated with the paste of chalk or red lead and allowed to dry.
- Then the work is held In a holding device depending upon shape and size.
- If it is flat, use surface plate, if it is round use V block and clamp, else use angle plate etc.
- Lines in horizontal direction are scribed by means of a surface gauge.
- Lines at right angles can be drawn by turning the work through 90 degree and then using the scriber.
- If true surface is available, try square can also be used.
- The centre on the end of a round bar can be located by using an odd leg caliper, surface gauge etc.
- The circles and arcs on a flat surface are marked by means of a divider.
- After the scribing work is over, indentations on the surface are made using dot punch and hammer.

IV. CUTTING TOOL

1. Hacksaw

Hacksaw is used for cutting of rods, bars, pipes, flats etc. It consists of a frame, which is made from mild steel. The blade is placed inside the frame and is tightened with the help of a flange nut. The blade is made up of high carbon steel or high speed steel

The points of the teeth are bent in a zig-zag fashion, to cut a wide groove and prevent the body of the blade from rubbing or jamming in the saw cut. The teeth of the blades are generally forward cut so in the case, pressure is applied in the forward direction only.

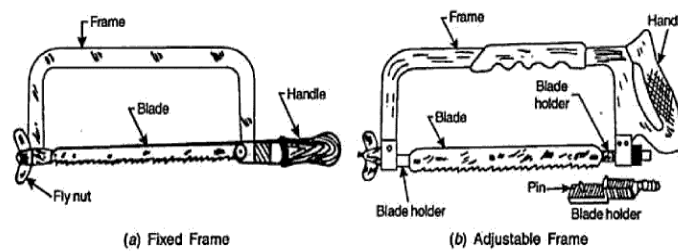

Fig. Hand Hacksaws

Fig. 13 Hand Hacksaw

Depending upon the direction of cut, blades are classified as:

o Forward cut o Backward cut.

Depending upon the pitch of the teeth (Distance between the two consecutive teeth) blades is classified as:

- Coarse (8-14 teeth per Inch)
- Medium (16-20 teeth per inch)
- Fine (24-32 teeth per inch)

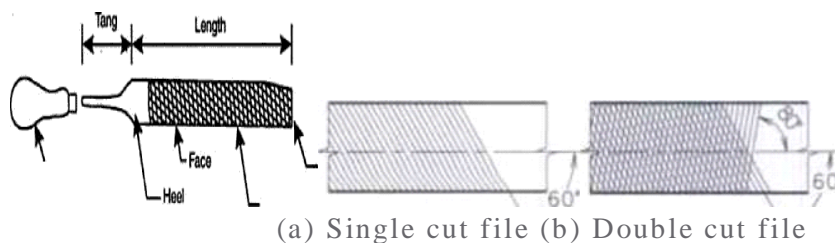

Fig. 14 Files

Files are multi points cutting tools. It is used to remove the material by rubbing it on the metals. Files are available in a number of sizes, shapes and degree of coarseness.

Classification of file On the basis of length 4",6",8",12"

- On the basis of grade:
 - Rough (R)(20 teeth per inch)
 - Bastard (B)(30 teeth per inch)
 - Second cut (Sc) (40 teeth per inch)
 - Smooth file (S)(50 teeth per inch)
 - Dead smooth (DS)(100 teeth per inch)

Rough and bastard files are the big cut files. When the material removal is more, these files are used. These files have bigger cut but the surface produced is rough.

Dead smooth and smooth files have smaller teeth and used for finishing work. Second cut file has degree of finish in between bastard and smooth file. iv. On the basis of number of cuts:

- Single cut files.
- Double cut files.
- Rasp files.



(a) Rasp cut file



(b) Knife edge file

Fig. 15 Different files

In single cut files the teeth are cut in parallel rows at an angle of 60 degree to the face. Another row of teeth is added in opposite direction in case of double cut files. Material removal is more in case of double cut files.

- On the basis of shape and size:



(a) Flat file



(b) Hand file



(c) Square file



(d) Round file



(f) Triangular file



(g) Diamond file

Fig. 16 Edges of files

- The length of the files varies from 4' to 14*. The various shapes of cross-section available are hand file, flat file, triangular, round; square, half round, knife-edge, pillar, needle and mill file. Flat file: This file has parallel edges for about two-thirds of the length and then it tapers in width and thickness. The faces are double cut while the edges are single cut.
- Hand file: for a hand file the width is constant throughout, but the thickness tapers as given in flat file. Both faces are double cut and one edge is single cut. The remaining edge is kept uncut in order to use for filing a right-angled corner on one side only.
- Square file: It has a square cross-section. It is parallel for two-thirds of its length and then tapers towards the tip. It is double cut on all sides. It is used for filing square corners and slots.
- Triangular file: It has width either parallel throughout or up to middle and then tapered towards the tip. Its section is triangular (equilateral) and the three faces are double cut and the edges single cut. It is used for filing square shoulders or comers and for sharpening wood working saws.
- Round file: It has round cross-section. It carries single cut teeth all round its surface. It is normally made tapered towards the tip and is frequently known as rat-tail file. Parallel

round files having same diameter throughout the length are also available. The round files are used for opening out holes, producing round comers, round-ended slots etc.

- Half-round file: Its cross-section is not a true half circle but is only about one-third of a circle. The width of the file is either parallel throughout or up to middle and then tapered towards the tip. The flat side of this file is always a double cut and curved side has single cut. It is used for filing curved surfaces.
- Knife edge file: It has a width tapered like a knife blade and it is also tapered towards the tip and thickness. It carries double cut teeth on the two broad faces and single cut teeth on the edge. It is used for finishing sharp corners of grooves and slots
- Diamond file: Its cross-section is like a diamond. It is used for special work.
- Needle file: These are thin small files having a parallel tang and a thin, narrow and pointed blade made in different shapes of its cross-section to suit the particular need of the work. These are available in sizes from 100 mm to 200 mm of various shapes and cuts. These files are used for filing very thin and delicate work.

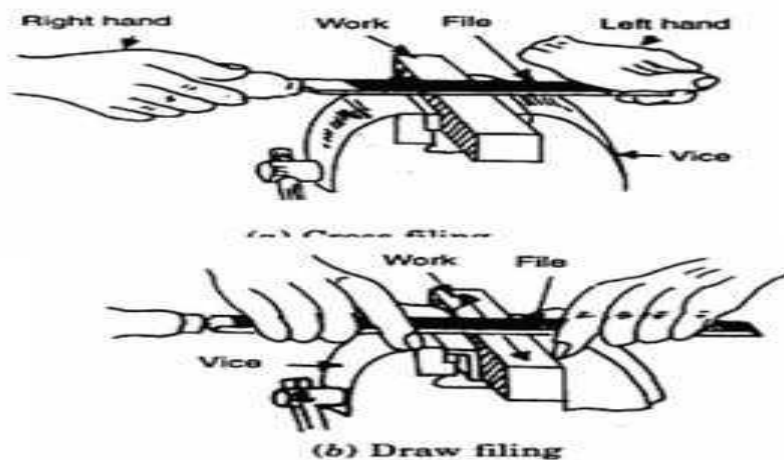

Fig. 17 Methods of filing

- **Methods of filing**

The following are the two commonly used methods of filing:

- Cross-filing 2. Draw filing.

Cross - filing. Refer Fig. (a).

This method is used for efficient removal of maximum amount of metal in the shortest possible time. It may be noted that the file must remain horizontal throughout the stroke (long, slow and steady) with pressure only applied on the forward motion.

Draw filing. Refer Fig. (b)

This method is used to remove file marks and for finishing operations. Here, the file is gripped as close to the work as possible between two hands. In this filing method, a fine cut file with a flat face should be used.

FILE CARD:

It is a device fashioned like a wire brush used to clean dirt and chips from the teeth of a file. When particles of metal clog the teeth the file is said to be *pinned*, a condition that causes scratching of the surface of the work. Files, therefore, require cleaning by means of a file card or by dislodging the material between the teeth by means of a piece of soft iron, copper, brass, tin plate and so on, sharpened at the end. Hardened steel should *never* be used

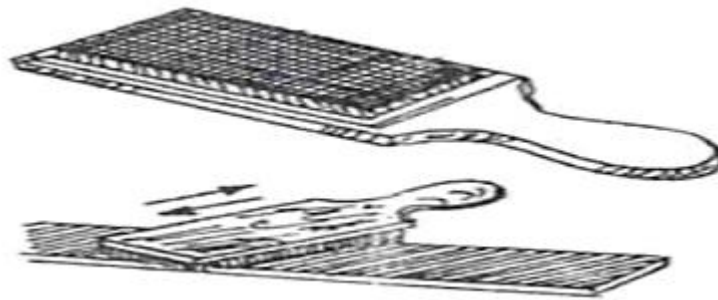

Fig. 18 File card

EXPERIMENT – 1

SQUARE CUTTING

AIM: To make a Square fit from the given mild steel pieces.

MATERIALS REQUIRED: mild steel flat (40*40*3mm).

TOOLS AND EQUIPMENT REQUIRED:

1. 6" try square
2. 6" scribe
3. 12" hack saw Frame 4 Blades (12 TPI)
5. 10" rough file
6. 10" smooth file
7. 10" square file
8. Dot punch
9. Ball peen hammers (0.5 lb).
10. Steel Rule

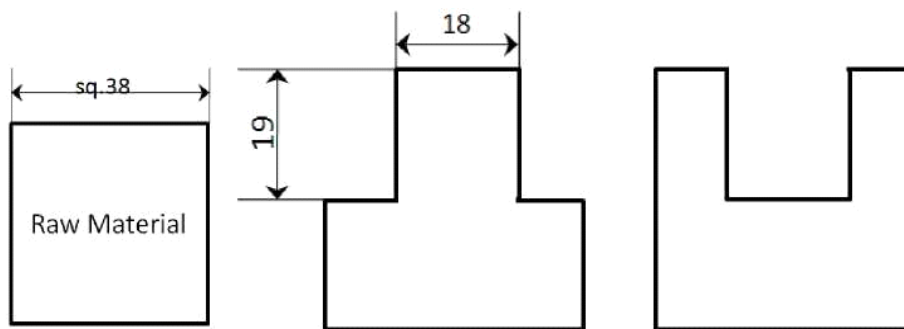

Operations to be carried out:

- Filing
- Marking
- Punching
- Sawing
- Filing
- Finishing

PROCEDURE:

- The given mild steel flat piece is checked for given dimensions.
- One edge of given is filed to straightness with rough and smooth files and checked with try square.
- An adjacent is also filed such that is square to first edge and checked with try square.
- Wet chalk is applied on one side of the flat and dried for marking.
- Lines are marked according to given figure, using odd leg caliper and steel rule.
- Using the dot punch are made along the marked lines.

- The excess materials removed from the remaining two edges with try square level up to half of the marked dots.
- Finally butts are removed by the filling on the surface of the fitted job.

PRECAUTIONS:

- The perpendicularity of face ends edges is checked perfectly by using try square.
- Finishing is given by using only with smooth files.
- Marking is done without parallax error.

RESULT: The L-Shape fitting is done successfully.

EXPERIMENT – 2

V-SHAPE FITTING

AIM: To make a V-Fit from the given mild steel pieces. **MATERIALS REQUIRED:** Mild steel flat (40*40*3mm).

TOOLS AND EQUIPMENT REQUIRED:

- 6"try square

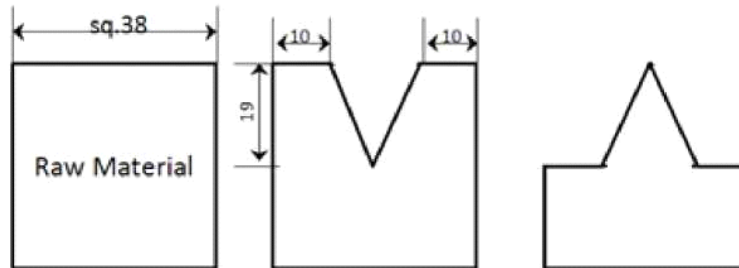

- 6"scriber
- Odd leg caliper 3.12"hack saw Frame 4 Blades (12 TPI)
- 5.10"rough file 6.10"smooth file 7.10"triangle file
- Knife Edge file
- Dot punch
- Ball peen hammer (0.5 lb)
- Steel Rule

SEQUENCE OF OPERATIONS:

- Filing
- Marking
- Punching
- Sawing
- Filing
- Finishing

PROCEDURE:

- The given mild steel flat piece is checked for given dimensions.
- One edge of given is filled with rough and smooth files and checked with try square for straightness.
- An adjacent edge is also filled such that it is square to first edge and checked with try square.
- Wet chalk is applied on one side of the flat and dried for marking.
- Lines are marked according to given figure, using odd leg caliper and steel rule.
- Using the dot punch, punches are made along the marked lines.
- The excess materials removed from the remaining two edges with try square level up to half of the marked dots.

- Finally butts are removed by the filling on the surface of the fitted job.

PRECAUTIONS:

- The perpendicularity of face ends edges is checked perfectly by using try square.
- Finishing is given by using only with smooth files.
- Marking is done without parallax error.

RESULT: The V-fit is done successfully.

FOUNDRY

PATTERN

A pattern is a model or the replica of the object (to be casted). It is embedded in molding sand and suitable ramming of molding sand around the pattern is made. The pattern is then withdrawn for generating cavity (known as mold) in molding sand.

COMMON PATTERN MATERIALS

The common materials used for making patterns are wood, metal, plastic, plaster, wax or Mercury.

TYPES OF PATTERN

The types of the pattern and the description of each are given as under.

- One piece or solid pattern 2. Two piece or split pattern 3. Cope and drag pattern 4. Three-piece or multi- piece pattern 5. Loose piece pattern 6. Match plate pattern 7. Follow board pattern 8. Gated pattern
- Sweep pattern 10. Skeleton pattern 11. Segmental or part pattern
- Single-piece or solid pattern: Solid pattern is made of single piece without joints, partings lines or loose pieces. It is the simplest form of the pattern. Typical single piece pattern is shown in Fig. 10.1.

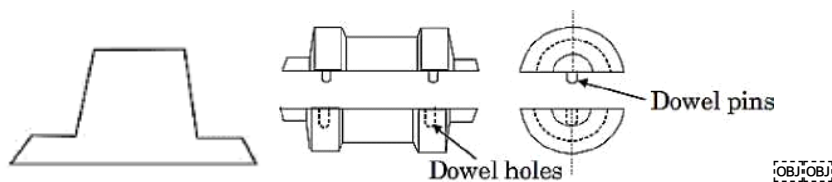

(a)Single piece pattern

(b)Two piece pattern

Fig. 1 Types of pattern

- Two-piece or split pattern: When solid pattern is difficult for withdrawal from the mold cavity, then solid pattern is split in two parts. Split pattern is made in two pieces which are joined at the parting line by means of dowel pins. The splitting at the parting line is done to facilitate the withdrawal of the pattern. A typical example is shown in Fig.

The general sources of receiving molding sands are the beds of sea, rivers, lakes, granular elements of rocks, and deserts.

Molding sands may be of two types namely natural or synthetic. Natural molding sands contain sufficient binder. Whereas synthetic molding sands are prepared artificially using basic sand molding constituents (silica sand in 88-92%, binder 6-12%, water or moisture content 3-6%) and other additives in proper proportion by weight with perfect mixing and mulling in suitable equipments.

Binder

In general, the binders can be either inorganic or organic substance. The inorganic group includes clay sodium silicate and port land cement etc. In foundry shop, the clay acts as binder which may be Kaolonite, Ball Clay, Fire Clay, Limonite, Fuller's earth and Bentonite. Binders included in the

organic group are dextrin, molasses, cereal binders, linseed oil and resins like phenol formaldehyde, urea formaldehyde etc. Organic binders are mostly used for core making.

Among all the above binders, the bentonite variety of clay is the most common. However, this clay alone cannot develop bonds among sand grains without the presence of moisture in molding sand and core sand.

Additives

Additives are the materials generally added to the molding and core sand mixture to develop some special property in the sand. Some common used additives for enhancing the properties of molding and coresands are discussed as under.

- Coal dust: Coal dust is added mainly for producing a reducing atmosphere during casting.
- Corn flour: It belongs to the starch family of carbohydrates and is used to increase the collapsibility of the molding and core sand
- Dextrin: Dextrin belongs to starch family of carbohydrates that behaves also in a manner similar to that of the corn flour. It increases dry strength of the molds.
- Sea coal: Sea coal is the fine powdered bituminous coal which positions its place among the pores of the silica sand grains in molding sand and core sand
- Wood flour: This is a fibrous material mixed with a granular material like sand; its relatively long thin fibers prevent the sand grains from making contact with one another.
- Silica flour: It is called as pulverized silica and it can be easily added up to 3% which increases the hot strength and finish on the surfaces of the molds and cores

KINDS OF MOULDING SAND

Molding sands can also be classified according to their use into number of varieties which are described below.

- Green sand: Green sand is also known as tempered or natural sand which is a just prepared mixture of silica sand with 18 to 30 percent clay, having moisture content from 6 to 8%. The clay and water furnish the bond for green sand. It is fine, soft, light, and porous.
- Dry sand: Green sand that has been dried or baked in suitable oven after the making mold and cores, is called dry sand. It possesses more strength, rigidity and thermal stability.
- Loam sand: Loam is mixture of sand and clay with water to a thin plastic paste. Loam sand possesses high clay as much as 30-50% and 18% water.
- Facing sand: Facing sand is just prepared and forms the face of the mould. It is directly next to the surface of the pattern and it comes into contact molten metal when the mould is poured. Initial coating around the pattern and hence for mold surface is given by this sand. This sand is subjected severest conditions and must possess, therefore, high strength refractoriness.
- Backing sand: Backing sand or floor sand is used to back up the facing sand and is used to fill the whole volume of the molding flask.
- Parting sand: Parting sand without binder and moisture is used to keep the green sand not to stick to the pattern and also to allow the sand on the parting surface the cope and drag to separate without clinging
- Core sand: Core sand is used for making cores and it is sometimes also known as oil sand. This is highly rich silica sand mixed with oil binders such as core oil which composed of linseed oil, resin, light mineral oil and other bind materials.

PROPERTIES OF MOULDING SAND

The basic properties required in molding sand and core sand are described as under.

- **Refractoriness:** Refractoriness is defined as the ability of molding sand to withstand high temperatures without breaking down or fusing thus facilitating to get sound casting. It is a highly important characteristic of molding sands. Refractoriness can only be increased to a limited extent
- **Permeability:** It is also termed as porosity of the molding sand in order to allow the escape of any air, gases or moisture present or generated in the mould when the molten metal is poured into it. All these gaseous generated during pouring and solidification process must escape otherwise the casting becomes defective
- **Cohesiveness:** It is property of molding sand by virtue which the sand grain particles interact and attract each other within the molding sand
- **Green strength:** The green sand after water has been mixed into it, must have sufficient strength and toughness to permit the making and handling of the mould. For this, the sand grains must be adhesive, i.e. they must be capable of attaching themselves to another body
- **Dry strength:** As soon as the molten metal is poured into the mould, the moisture in the sand layer adjacent to the hot metal gets evaporated and this dry sand layer must have sufficient strength to its shape in order to avoid erosion of mould wall during the flow of molten metal
- **Flowability or plasticity:** It is the ability of the sand to get compacted and behave like a fluid. It will flow uniformly to all portions of pattern when rammed and distribute the ramming pressure evenly all around in all directions
- **Adhesiveness:** It is property of molding sand to get stick or adhere with foreign material such sticking of molding sand with inner wall of molding box
- **Collapsibility:** After the molten metal in the mould gets solidified, the sand mould must be collapsible so that free contraction of the metal occurs and this would naturally avoid the tearing or cracking of the contracting metal.

HAND TOOLS USED IN FOUNDRY SHOP

Hand riddle:

It consists of a screen of standard circular wire mesh equipped with circular wooden frame. It is generally used for cleaning the sand for removing foreign material such as nails, shot metal, splinters of wood etc. from it. Even power operated riddles are available for riddling large volume of sand.

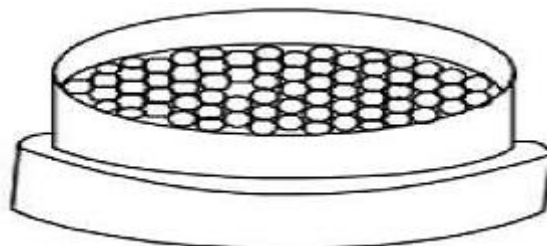

Fig .2 Hand riddle

Shovel: It consists of a steel pan fitted with a long wooden handle. It is used in mixing, tempering and conditioning the foundry sand by hand. It is also used for moving and transforming the molding sand to the container and molding box or flask.



Fig.3 Showel

Rammers: Rammers are shown in Fig. These are required for striking the molding sand mass in the molding box to pack or compact it uniformly all around the pattern.

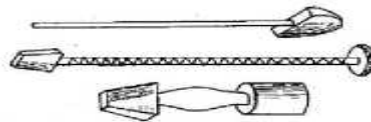

Fig.4 Rammers

Sprue pin: It is a tapered rod of wood or iron which is placed or pushed in cope to join mold cavity while the molding sand in the cope is being rammed.

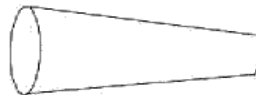

Fig.5 Sprue Pin

Trowels: These are used for finishing flat surfaces and comers inside a mould. Common shapes of trowels are shown as under. They are made of iron with a wooden handle.

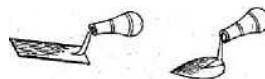
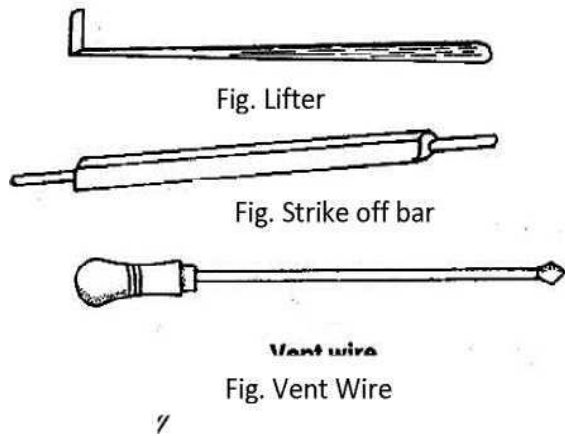

Fig.6 Trowels



Lifter: A lifter is a finishing tool used for repairing the mould and finishing the mould sand. Lifter is also used for removing loose sand from mould.



Fig.7 Lifter

Strike off bar: It is a flat bar, made of wood or iron to strike off the excess sand from the top of a box after ramming. Its one edge made beveled and the surface perfectly smooth and plane.

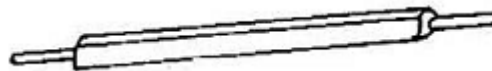

Fig.8 Strike off bar

Vent wire: It is a thin steel rod or wire carrying a pointed edge at one end and a wooden handle or a bent loop at the other. After ramming and striking off the excess sand it is used to make small holes, called vents, in the sand mould to allow the exit of gases and steam during casting.



Fig.9 Vent wire

Slicks: They are also recognized as small double ended mold finishing tool which are generally used for repairing and finishing the mold surfaces and their edges after withdrawal of the pattern.



Fig. 10 Slicks

Swab: Swab it is a small hemp fiber brush used for moistening the edges of sand mould, which are in contact with the pattern surface before withdrawing the pattern. It is used for sweeping away the molding sand from the mold surface and pattern.



Fig. 11 Swab

Gate cutter: Gate cutter is a small shaped piece of sheet metal commonly used to cut runners and feeding gates for connecting sprue hole with the mold cavity.



Fig.12 Gate cutter

Bellows: Bellows gun is it is hand operated leather made device equipped with compressed air jet to blow or pump air when operated. It is used to blow away the loose or unwanted sand from the surfaces of mold cavities.

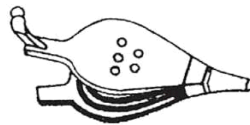

Fig. 13 Bellows

Draw spike: Draw spike it is a tapered steel rod having a loop or ring at its one end and a sharp point at the other. It may have screw threads on the end to engage metal pattern for its withdrawal from the mold.

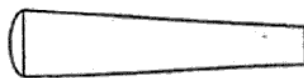

Fig. 14 Draw Spike

Sprue Pin: It is a tapered wooden pin, used to make a hole in the cope through which the molten metal is poured into the mould.

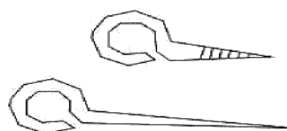

Fig. 15 Sprue Pin

MOULDING BOX:

Moulding box is also called moulding flask. It is frame or box of wood or metal. It is made of two parts cope and drag as shown in figure.

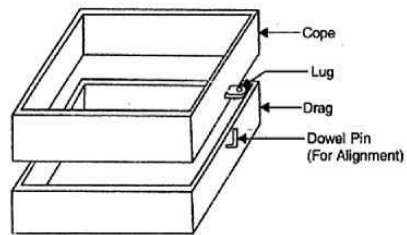

Fig. 16 Moulding Box

EXPERIMENT – 1

MOULD FOR A SOLID

Aim: To prepare a sand mold, using the given single piece pattern.

Raw material required: Moulding sand, Parting sand, facing sand, baking sand, single piece solid pattern, bottom board, moulding boxes etc.

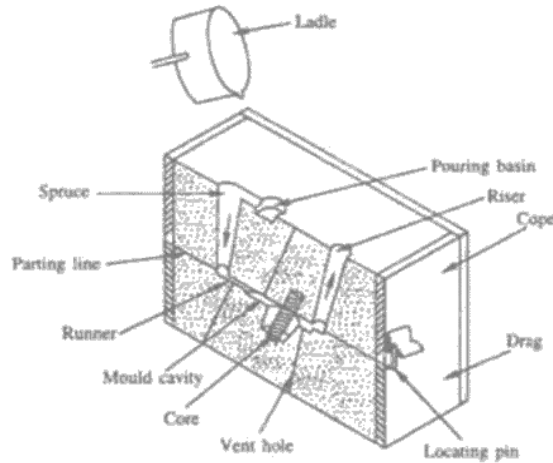

Tools Required:

- Molding board
- Drag and cope boxes
- Molding sand
- Parting sand
- Rammer
- Strike-off bar
- Bellows
- Riser and sprue pins
- Gate cutter
- Vent rod
- Draw spike
- Wire Brush

Sequence of operations:

- Sand preparation
- Placing the mould flask(drag) on the moulding board/ moulding platform
- Placing the pattern at the centre of the moulding flask
- Ramming the drag
- Placing runner and riser
- Ramming the cope

- Removal of the pattern, runner, riser
- Gate cutting

Procedure: Mould Making

- First a bottom board is placed either on the molding platform or on the floor, making the surface even.
- The drag molding flask is kept upside down on the bottom board along with the drag part of the pattern at the centre of the flask on the board.
- Dry facing sand is sprinkled over the board and pattern to provide a non-sticky layer.
- Freshly prepared molding sand of requisite quality is now poured into the drag and on the pattern to a thickness of 30 to 50 mm.
- Rest of the drag flask is completely filled with the backup sand and uniformly rammed to compact the sand.
- After the ramming is over, the excess sand in the flask is completely scraped using a flat bar to the level of the flask edges.
- Now with a vent wire which is a wire of 1 to 2 mm diameter with a pointed end, vent holes are in the drag to the full depth of the flask as well as to the pattern to facilitate the removal of gases during casting solidification. This completes the preparation of the drag.
- Now finished drag flask is rolled over to the bottom board exposing the pattern.
- Using a slick, the edges of sand around the pattern is repaired
- The cope flask on the top of the drag is located aligning again with the help of the pins of the drag box.
- Sprue of the gating system for making the sprue passage is located at a small distance of about 50 mm from the pattern. The sprue base, runners and in-gates are also located as shown risers are also placed. Freshly prepared facing sand is poured around the pattern.
- The moulding sand is then poured in the cope box. The sand is adequately rammed, excess sand is scraped and vent holes are made all over in the cope as in the drag.
- The sprue and the riser are carefully withdrawn from the flask
- Later the pouring basin is cut near the top of the sprue.
- The cope is separated from the drag any loose sand on the cope and drag interface is blown off with the help of the bellows.
- Now the cope and the drag pattern halves are withdrawn by using the draw spikes and rapping the pattern all around to slightly enlarge the mould cavity so that the walls are not spoiled by the withdrawing pattern.
- The runners and gates are to be removed or to be cut in the mould carefully without spoiling the mould.

- Any excess or loose sand is applied in the runners and mould cavity is blown away using the bellows.
- Now the facing paste is applied all over the mould cavity and the runners which would give the finished casting a good surface finish.
- A dry sand core is prepared using a core box. After suitable baking, it is placed in the mould cavity.
- The cope is placed back on the drag taking care of the alignment of the two by means of the pins.
- The mould is ready for pouring molten metal. The liquid metal is allowed to cool and become solid which is the casting desired.

Result: The required mould cavity is prepared using the given Single /solid Pattern.

EXPERIMENT – 2

MOULD FOR A SPLIT PATTERN.

Aim: To prepare a sand mold, using the given Split-piece pattern.

Raw Material required: Moulding sand, Parting sand, facing sand, baking sand, pattern, bottom board, moulding boxes.

Tools Required:

- Molding board
- Drag and cope boxes
- Molding sand
- Parting sand
- Rammer
- Strike-off bar
- Bellows
- Riser and sprue pins
- Gate cutter
- Vent rod
- Draw spike
- Wire Brush

Sequence operations

- Sand preparation
- Placing the mould flask(drag) on the moulding board/ moulding platform
- Placing the split pattern at the centre of the moulding flask
- Ramming the drag
- Placing the pattern at the centre of the moulding flask (Cope box)
- Placing runner and riser
- Ramming the cope
- Removal of the pattern, runner, riser
- Gate cutting

Procedure:

- Mould Making
- First a bottom board is placed either on the molding platform or on the floor, making the surface even.
- The drag molding flask is kept upside down on the bottom board along with the drag part of the pattern at the centre of the flask on the board.
- Dry facing sand is sprinkled over the board and pattern to provide a non-sticky layer.

- Freshly prepared molding sand of requisite quality is now poured into the drag and on the split-pattern to a thickness of 30 to 50 mm. Rest of the drag flask is completely filled with the backup sand and uniformly rammed to compact the sand.
- After the ramming is over, the excess sand in the flask is completely scraped using a flat bar to the level of the flask edges.
- Now with a vent wire which is a wire of 1 to 2 mm diameter with a pointed end, vent holes are in the drag to the full depth of the flask as well as to the pattern to facilitate the removal of gases during casting solidification. This completes the preparation of the drag.
- Now finished drag flask is rolled over to the bottom board exposing the pattern.
- Using a slick, the edges of sand around the pattern is repaired and cope half of the pattern is placed over the drag pattern, aligning it with the help of dowel pins
- The cope flask on the top of the drag is located aligning again with the help of the pins of the drag box.
- Dry parting sand is sprinkled all over the drag surface and on the pattern
- Sprue of the gating system for making the sprue passage is located at a small distance of about 50 mm from the pattern. The sprue base, runners and ingates are also located as shown risers are also placed. Freshly prepared facing sand is poured around the pattern.
- The moulding sand is then poured in the cope box. The sand is adequately rammed, excess sand is scraped and vent holes are made all over in the cope as in the drag.
- The sprue and the riser are carefully withdrawn from the flask
- Later the pouring basin is cut near the top of the sprue.
- The cope is separated from the drag any loose sand on the cope and drag interface is blown off with the help of the bellows.
- Now the cope and the drag pattern halves are withdrawn by using the draw spikes and rapping the pattern all around to slightly enlarge the mould cavity so that the walls are not spoiled by the withdrawing pattern.
- The runners and gates are to be removed or to be cut in the mould carefully without spoiling the mould.
- Any excess or loose sand is applied in the runners and mould cavity is blown away using the bellows.
- Now the facing paste is applied all over the mould cavity and the runners which would give the finished casting a good surface finish.
- A dry sand core is prepared using a core box. After suitable baking, it is placed in the mould cavity.

- The cope is placed back on the drag taking care of the alignment of the two by means of the pins.

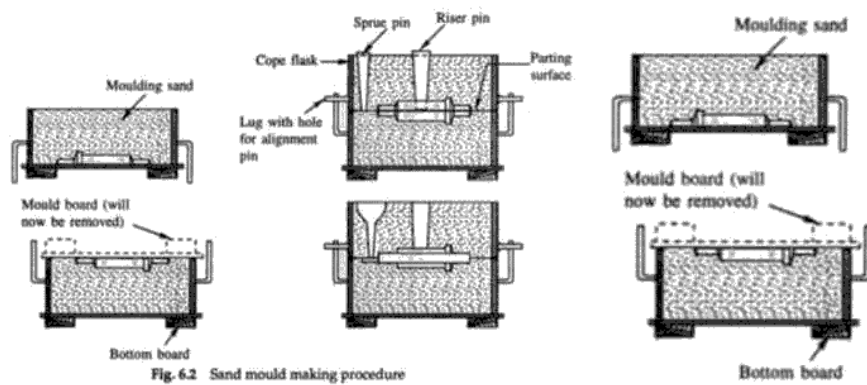

The mould is ready for pouring molten metal. The liquid metal is allowed to cool and become solid which is the casting desired.

Result: The required mould cavity is prepared using the given

Step -1: Place Drag part of the pattern on mould board and filled with mould sand

Step -2: Turn drag box upside down and Place cope box over drag box.

Step -3: place cope part of the pattern, riser, Sprue, runner in position and filled with mould sand.

Step-4: Finally the Mould cavity is produced by removing the pattern

SHEET METAL WORK

• INTRODUCTION

Sheet metal work has its own significance in the engineering work. Many products, which fulfill the household needs, decoration work and various engineering articles, are produced from sheet metals. Common examples of sheet metal work are hoopers, canisters, guards, covers, pipes, hoods, funnels, bends, boxes etc. Such articles are found less expensive, lighter in weight and in some cases sheet metal products replace the use of castings or forgings.

• METALS USED IN SHEET METAL WORK:

A metal plate of thickness less than 4 mm is considered as sheet. The size of the sheet is specified by its length, width and thickness in mm. In British system, the thickness of sheet is specified by a number called Standard Wire Gauge (SWG). The commonly used gauge numbers and the equivalent thickness in mm are given below

| | | | | | | | | | |
|-------------------|------|------|------|------|------|------|------|------|------|
| SWG (No.) | 16 | 17 | 18 | 19 | 20 | 22 | 24 | 27 | 30 |
| Thickness (mm) | 1.62 | 1.42 | 1.22 | 1.02 | 0.91 | 0.71 | 0.56 | 0.42 | 0.37 |

The following metals are generally used in sheet metal work:

- **Black Iron Sheet**

It is the cheapest among ail. It has a bluish-black appearance and is uncoated sheet. Being uncoated, it corrodes rapidly. It is prepared by rolling to the desired thickness, then annealed by pleasing in a furnace and then set aside to cool gradually. The use of this metal is limited to articles that are to be painted or enameled such as stovepipes, tanks, pans etc.

- **Galvanized Iron**

It is soft steel coated with molten zinc. This coating resist rust, improves appearances, improves solderability, and improves water resistance. It is popularly known as G.I. sheets. Articles such as pans, buckets, furnaces, cabinet etc. are made from GI sheets.

- **Stainless Steel**

It is an alloy of steel with nickel, chromium and traces of other metals. It has good corrosive resistance. The cost of stainless steel is very high but tougher than GI sheets. It is used in kitchenware, food handling equipment, chemical plants etc.

- **Copper**

It is a reddish colored metal and is extremely malleable and ductile. Copper sheets have good corrosion resistance as well as good appearances but costs are high as compared to GI and stainless steel. Because of high thermal conductivity, it is used for the radiator of automobiles, domestic heating appliances etc.

- **Aluminum**

Aluminum cannot be used in its pure form, but is used in alloy form. Common additions are copper, silicon, manganese and iron. It has many qualities like high ratio of strength to weight, corrosion resistant qualities, and ease in fabrication and whitish in color. It is used in manufacturing of a number of products such as refrigerator trays, household appliances, lighting fixtures, window work, construction of airplanes and in many electrical and transportation industries.

- **Tin Plates**

It is an iron sheet coated with the tin to protect it against rust. This metal has a very bright silvery appearance and is used principally in making food containers, cans and pans.

- **Lead**

It is a very soft, malleable, low melting point and possesses high resistance to acid corrosion. It is having low mechanical strength so it is used to provide lining to the highly corrosive acid tanks. It is also used in radiation shielding.

HAND TOOLS:

For measuring, marking cutting and forming, various types of hand tools are used in sheet metal work. A list of them is given below:

- Measuring tools
- Marking tools
- Cutting tools
- Forming tools
- Joining tools

MEASURING TOOLS

The following types of tools are commonly used in sheet metal shops to measure the dimensions of work pieces:

- Steel rule
- Vernier caliper
- Micrometer
- Sheet Metal gauge

The above tools are already explained in the fitting section.

SHEET METAL GAUGE

It is a disc shaped piece of metal, having a number of slots on the outside edge as shown in figure. The slots are of various widths and each corresponds to a certain standard wire gauge (SWG) number. The gauge is placed over the edge of the sheet to be measured and a slot is found that will slip over the metal with a light fit pressure. Standard tables are referred to for conversion of SWG numbers to mm sizes.

II. MARKING TOOLS:

- **Scriber:** It is used to scribe or mark line on a metal surface for a variety of purposes. It is a metalworker's pencil

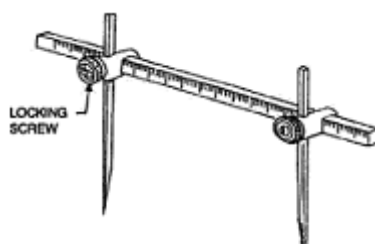

Fig.1 Scriber

- **Trammel:** These are used for drawing large circles and arcs that are beyond the limit of dividers. It has two straight, removable legs tapered to a needle point mounted on separate holders which slide on steel (or wooden) bar and held in position by thumb screws.
- **Punches:** It is used in sheet metal work for marking on sheet, locating centers. There are two types of punches. a) Dot punch and b) Prick punch.

These are already explained in fitting section in detail.

III CUTTING TOOLS:

To cut the sheet metal as per the pattern drawn and to make holes for rivets etc., the following types of tools are used.

A snip is a hand shear used to cut thin sheets of gauge size number 20 or above. It works like ordinary scissors. There are several types and sizes of snips available to cut along straight lines or curved lines.

Figure (a) shows a straight snip having straight blades to cut along straight lines. Figure (b) shows a bent snip having curved blades to cut along curved lines. These snips are used for cutting thin sheets. The heavier types are known as bench shear and block shear.

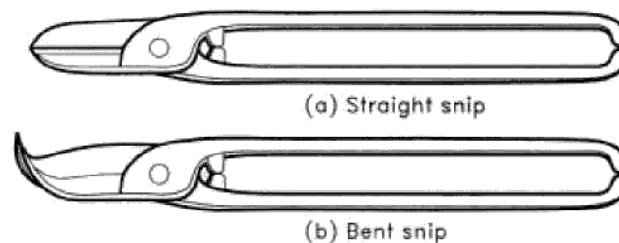

Fig.2 Types of snips

IV. FORMING TOOLS:

Shaping of the sheet metal such as folding, bending, curling, etc., are done by using the following types of forming tools.

- **Stakes:**

Stakes are the sheet metal anvils used for bending, seaming and forming by using a hammer or mallet. They work as the supporting tool as well as the forming tools. They are made in different sizes and shapes depending upon the job requirement. Commonly used stakes are

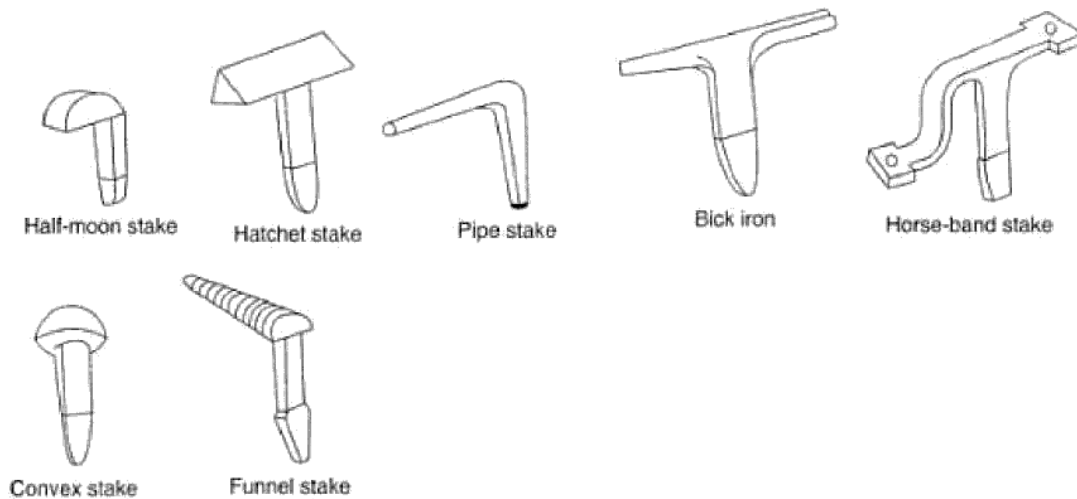

Fig.3 Types of Stakes

Stake Holder

The stake holder used in sheet metal shop is a rectangular bench plate as shown in Figure.

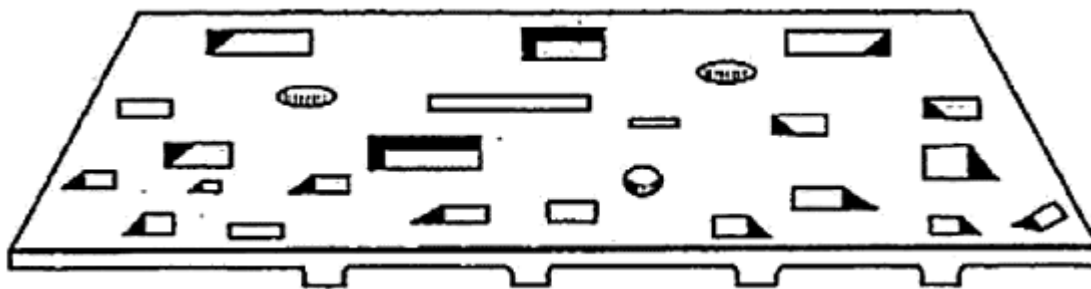

Fig.4 Stake Holder

• **HAMMERS:**

The sheet metal is shaped by hammering or striking with mallet, after keeping the work on suitable form of stake. The hammers used for sheet metal work are (a) Setting hammer, for setting down the edge while making double seam, (b) Raising hammer for forming curved or hollow shape from flat piece, and (c) Riveting hammer for riveting purpose. Mallets are soft hammers used to give soft blows which will not damage the sheet at the same time will shape them. The commonly used types of hammers and mallets are shown in Figure.

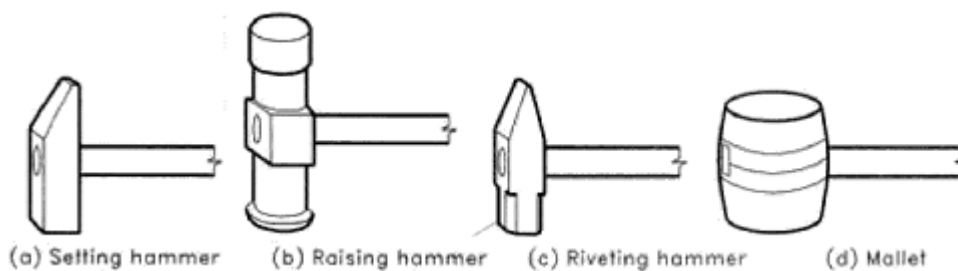

Fig.5 HAMMERS

The tools exclusively used for making and finishing joints are: a) Hand groovers b) Rivet set c)

Soldering irons

Hand groovers : Hand groovers are used to flatten and shape joints made in sheet metal. The tool has a groove of required width and depth like a die. This groover is placed over the joint (double hem or lock seam) and hammered from the top of it, to shape the joint that of the groove as shown figure.

RIVET SET:

Rivet get is made of tool steel. At the bottom of the rivet set there is a deep hole and a cup-shaped hole. The deep hole is used to draw a rivet through sheet metal and cup shaped hole is used to form the finished head of the rivet- Another hole on the aide of the set is to release the burrs that are punched. Dollies are used to backup rivets, when it is not possible to support the job on a bench.

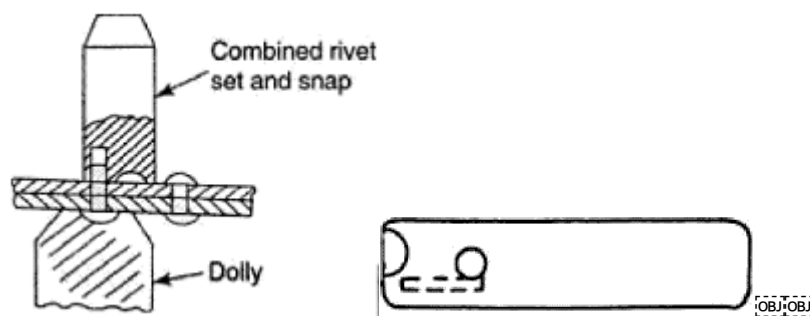

Fig .6 Rivet set

SOLDERING IRON:

A soldering iron consists of a copper block, fixed on an iron rod. These are available in various shapes and sizes to suit the use. The purpose of the copper clock is to act as a heat source for melting and spreading the solder (filler metal) at the joining area. The soldering iron (copper) is heated using furnace, blower or by electrical resistance.

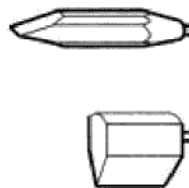

Fig.7 Soldering Iron

SHEET METAL JOINTS: The line of joint on a sheet me ml pieces is called seam. The most common types of seams are as follows:

- Lap seam: This is the simplest seam used in sheet metal work (Figure (a)). This consists of one edge lapping over the other and joint is made by soldering or riveting.
- Grooved seam: A grooved seam is made by hooking two-folded edges together and then off setting them as shown in Figure (b). This joint is self-locking and stronger to some extent than lap seam.

- Single seam: This seam is used to join a bottom portion to a vertical body as shown in Figure (c). The bottom edge is hooked over the bent edge of the vertical body. This method of joint can be used for square, rectangular or round containers.
- Double seam: This seam is similar to single seam with the difference that the formed edge is bent upwards against the body as shown in Figure (d).
- Dove-tail seam: This seam is used to connect a cylindrical piece to a flat as shown in Figure (e). The edge of the cylindrical part to be joined is slit at short distance and is bent so that alternate pieces come inside and outside of the joint. Permanent joint is obtained by soldering or riveting.

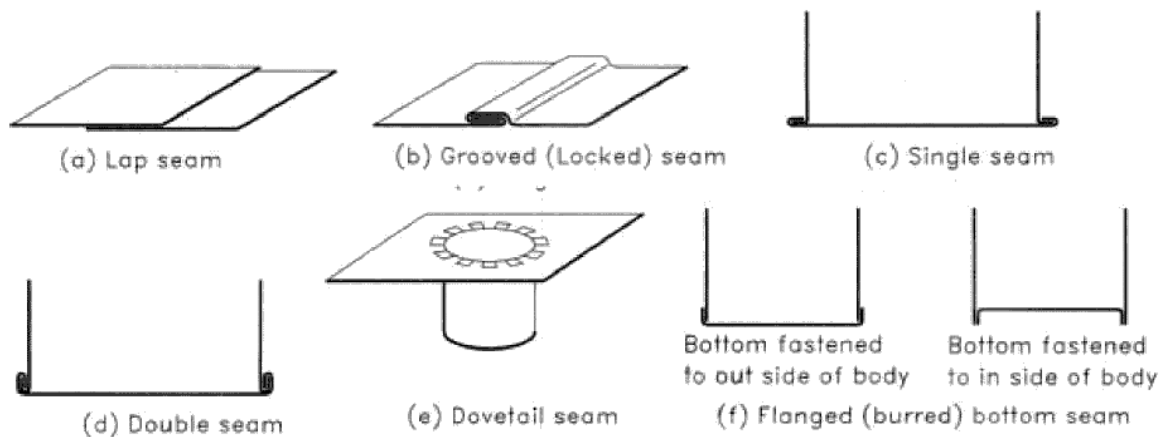

Fig. 8 Sheet Metal Joints

6. Flanged (burred) bottom seam:

This seam is used to fasten the bottom of a container to its body. The flange of a cylindrical job is often called a burr. The joint consists of a narrow flange which may be joined to inside or outside of the vessel as shown in figure (f).

Edge Forming

For sheet metal objects strength is given to the edge and the sharpness is eliminated by folding the edge. The common types of folding used in sheet metal work are as follows:

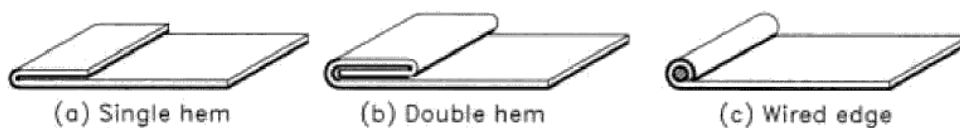

Fig.9 Edge Forming

Figure shows the three types of edge folding. A wired edge consists of an edge wrapped around a steel wire for better strength.

EXPERIMENT – 1

RECTANGULAR TRAY

AIM: To make a rectangular Tray as per required dimensions.

MATERIALS REQUIRED: Galvanized Iron sheet (150*110*26 gauge)

TOOLS AND EQUIPMENT REQUIRED:

- Steel rule
- Flat file
- Scriber
- Try square
- Snips
- Dot punch
- Stakes
- Mallet

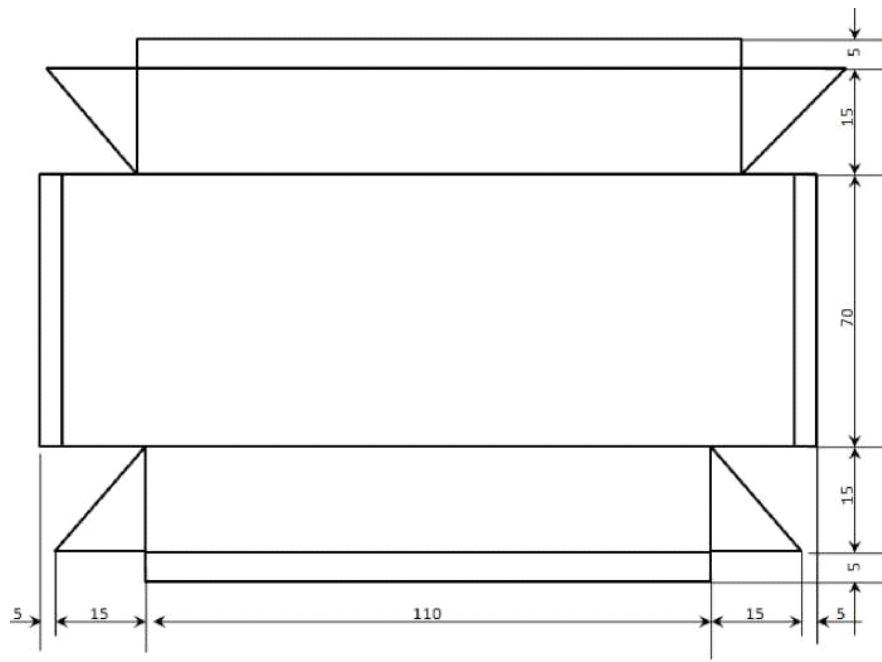

OPERATIONS TO BE CARRIED OUT:

- Planning
- Marking
- Cutting
- Bending
- Seaming
- Soldering

PROCEDURE:

- The size of the given sheet is checked with steel rule.
- Mark the measurement and make the development surface sketch diagram.
- The layout of the tray is marked on given sheet.
- The layout of the tray is cut by using the straight snips.
- The sheet is bent to the required shape using stakes and mallet.
- Now the bent edges are made to overlap each other and stuck with a mallet to get the required joint.
- The joint is soldered.

PRECAUTIONS:

- Care should be taken while cutting with snip.
- Care should be taken while bending and jumping.

RESULT:

The rectangular tray is done success fully made.

EXPERIMENT – 2**ROUND PIPE**

AIM: To make a cylindrical pipe as per required dimensions.

MATERIALS REQUIRED:

Galvanized Iron sheet (100*38*26 gauge)

TOOLS AND EQUIPMENT REQUIRED:

- Steel rule
- Flat file
- Scriber
- Try square
- Snips
- Dot punch
- Stakes
- Mallet

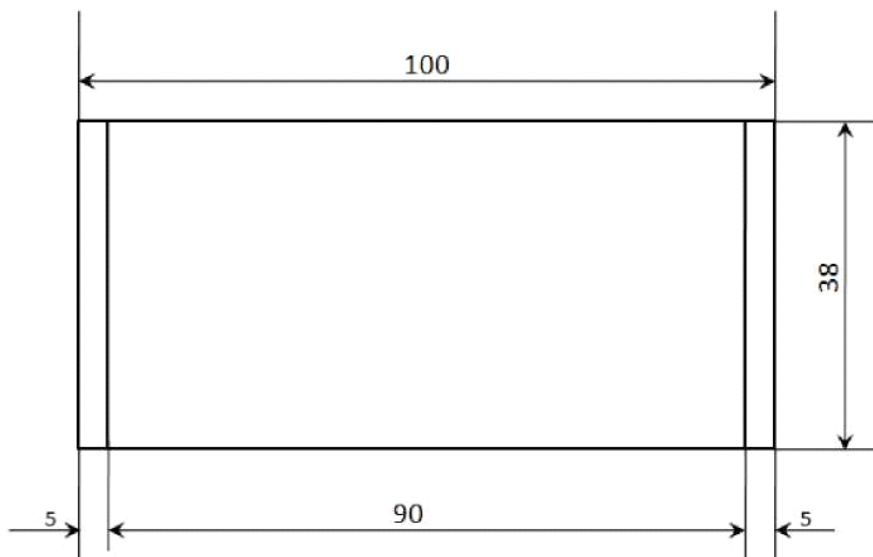
**OPERATIONS TO BE CARRIED OUT:**

- Planning
- Marking
- Cutting
- Bending
- Seaming
- Soldering

PROCEDURE:

- The size of the given sheet is checked with steel rule.

- Mark the measurement and make the development surface sketch diagram.
- The layout of the cylindrical shape pipe is marked on the given sheet.
- The sheet is bent to the required shape using stakes and mallet.
- Now the edges are slightly bent to one is one side and the other is opposite side, using stakes and mallet.
- Join both the ends with in a cylindrical shape.

PRECAUTIONS:

- Care must be taken while cutting snips.
- Care must be taken while bending and joining.

RESULT:

The cylindrical shape is made successfully.

WELDING

Welding is a process for joining two similar or dissimilar metals by fusion. It joins different metals/alloys, with or without the application of pressure and with or without the use of filler metal. The fusion of metal takes place by means of heat. The heat may be generated either from combustion of gases, electric arc, electric resistance or by chemical reaction.

Welding provides a permanent joint but it normally affects the metallurgy of the components. It is therefore usually accompanied by post weld heat treatment for most of the critical components. The welding is widely used as a fabrication and repairing process in industries. Some of the typical applications of welding include the fabrication of ships, pressure vessels, automobile bodies, off-shore platform, bridges, welded pipes, sealing of nuclear fuel and explosives, etc.

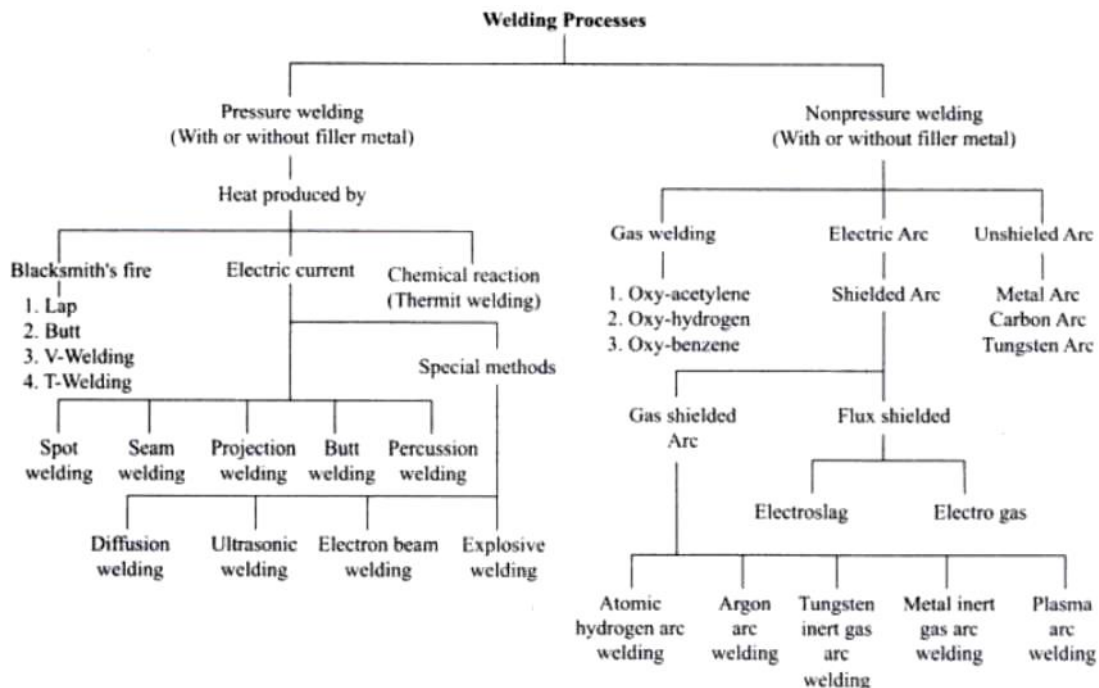

Fig. 1 Classification of Welding Processes

Most of the metals and alloys can be welded by one type of welding process or the other. However, some are easier to weld than others. To compare this ease in welding term ‘weldability’ is often used. The weldability may be defined as property of a metal which indicates the ease with which it can be welded with other similar or dissimilar metals. Elements of welding process used with common welding joints such as base metal, fusion zone, weld face, root face, root opening toe and root are depicted in Fig 2.

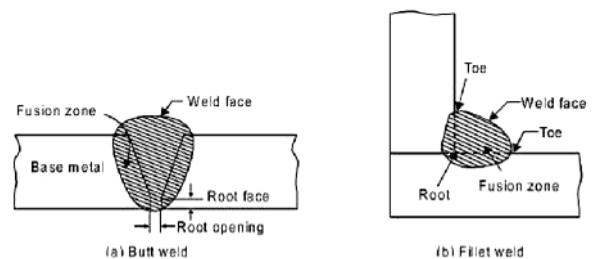

Fig. 2 Terminology of welding Process Edge

For welding the edges of joining surfaces of metals are prepared first. Different edge preparations may be used for welding butt joints, which are given in Figure 3.

Welding joints

Some common welding joints are shown in Figure. Welding joints are of generally of two major kinds namely lap joint and butt joint. The main types are described as under.

1. Lap weld joint Single-Lap Joint

This joint, made by overlapping the edges of the plate, is not recommended for most work. The single lap has very little resistance to bending. It can be used satisfactorily for joining two cylinders that fit inside one another.

Double-Lap Joint

This is stronger than the single-lap joint but has the disadvantage that it requires twice as much welding.

Tee Fillet Weld:

This type of joint, although widely used, should not be employed if an alternative design is possible.

2. Butt weld joint

a. Single-Vee Butt Weld

It is used for plates up to 15.8 mm thick. The angle of the vee depends upon the technique being used, the plates being spaced approximately 3.2 mm.

b. Double-Vee Butt Weld

It is used for plates over 13 mm thick when the welding can be performed on both sides of the plate. The top vee angle is either 60° or 80° , while the bottom angle is 80° , depending on the technique being used.

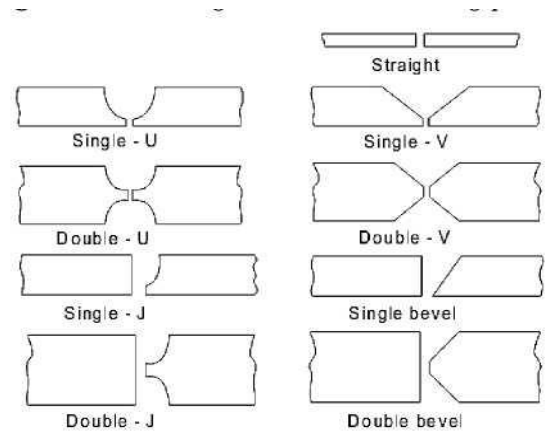

Fig. 3 Types of edges

Welding Positions

As shown in Fig. 4, there are four types of welding positions, which are given as:

- Flat or down hand position
- Horizontal position
- Vertical position
- Overhead position

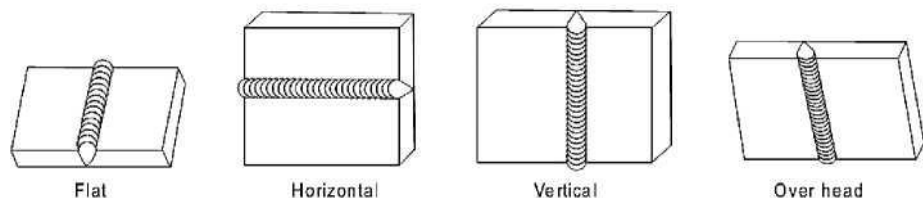

Fig. 4 Welding Positions

Flat or Down-hand Welding Position

The flat position or down hand position is one in which the welding is performed from the upper side of the joint and the face of the weld is approximately horizontal.

Horizontal Welding Position

In horizontal position, the plane of the work piece is vertical and the deposited weld head is horizontal. This position of welding is most commonly used in welding vessels and reservoirs.

Vertical Welding Position

In vertical position, the plane of the work-piece is vertical and the weld is deposited upon a vertical surface. It is difficult to produce satisfactory welds in this position due to the effect of the force of gravity on the molten metal.

Overhead Welding Position

The overhead position is probably even more difficult to weld than the vertical position. Here the pull of gravity against the molten metal is much greater.

ARC WELDING PROCESSES

The process, in which an electric arc between an electrode and a work-piece or between two electrodes is utilized to weld base metals, is called an arc welding process. The basic principle of arc welding is shown in Figure 5. However the basic elements involved in arc welding process are shown in Figure 6. Most of these processes use some shielding gas while others employ coatings or fluxes to prevent the weld pool from the surrounding atmosphere.

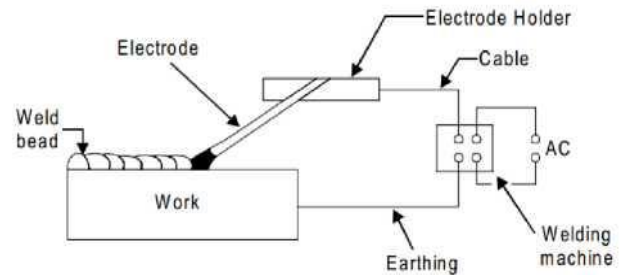

Fig1.The basic principle of arc welding

- 1) Switch box.
- 2) Secondary terminals
- 3) Welding machine.
- 4) Current reading scale.
- 5) Current regulating hand wheel.
- 6) Leather apron.
- 7) Asbestos hand gloves.
- 8) Protective glasses strap
- 9) Electrode holder.
- 10) Hand shield

- 11) Channel for cable protection.
- 12) Welding cable.
- 13) Chipping hammer.
- 14) Wire brush.
- 15) Earth clamp.
- 16) Welding table (metallic).
- 17) Job.

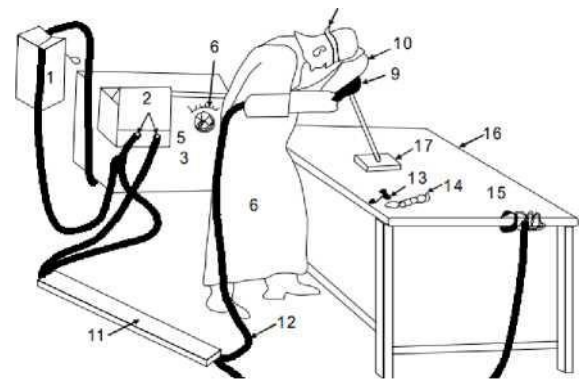

Fig2.The basic elements of arc welding

Fig .5 Elements of welding

Arc Welding Equipment

Arc welding equipment, setup and related tools and accessories are shown in Figure. However some common tools of arc welding are shown separately through Figure. Few of the important components of arc welding setup are described as under.

1. Arc welding power source

Both direct current (DC) and alternating current (AC) are used for electric arc welding, each having its particular applications. DC welding supply is usually obtained from generators driven by electric motor or if no electricity is available by internal combustion engines. For AC welding supply, transformers are predominantly used for almost all Arc-welding where mains electricity supply is available. They have to step down the usual supply voltage (200-400 volts) to the normal open circuit welding voltage (50-90 volts). The following factors influence the selection of a power source:

- a. Type of electrodes to be used and metals to be welded
- b. Available power source (AC or DC)
- c. Required output
- d. Duty cycle
- e. Efficiency
- f. Initial costs and running costs
- g. Available floor space
- h. Versatility of equipment

2. Welding cables

Welding cables are required for conduction of current from the power source through the electrode holder, the arc, the work piece and back to the welding power source. These are insulated copper or aluminum cables.

3. Electrode holder

Electrode holder is used for holding the electrode manually and conducting current to it. These are usually matched to the size of the lead, which in turn matched to the amperage output of the arc welder.

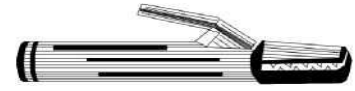

Fig. 6 Electrode Holder

Electrode holders are available in sizes that range From 150 to 500 Amps.

4. Welding Electrodes

An electrode is a piece of wire or a rod of a metal or alloy, with or without coatings. An arc is set up between electrode and work piece. Welding electrodes are classified into following types-

- (i) Consumable Electrodes
 - (a) Bare Electrodes
 - (b) Coated Electrodes
- (ii) Non-consumable Electrodes
 - (a) Carbon or Graphite Electrodes
 - (b) Tungsten Electrodes

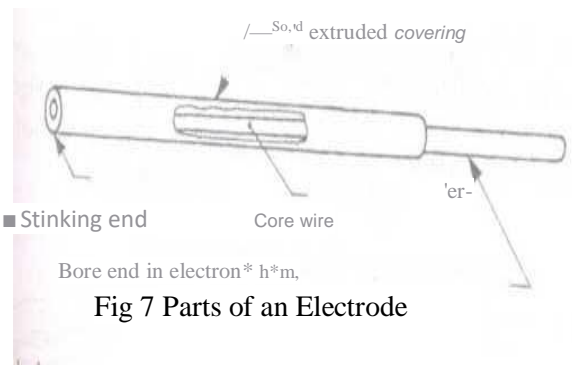

Fig 7 Parts of an Electrode

Consumable electrode is made of different metals and their alloys. The end of this electrode starts melting when arc is struck between the electrode and work piece. Thus consumable electrode itself acts as a filler metal. Bare electrodes consist of a metal or alloy wire without any flux coating on them. Coated electrodes have flux coating which starts melting as soon as an electric arc is struck. This coating on melting performs many functions like prevention of joint from atmospheric contamination, arc stabilizers etc.

Non-consumable electrodes are made up of high melting point materials like carbon, pure tungsten or alloy tungsten etc. These electrodes do not melt away during welding. But practically, the electrode length goes on decreasing with the passage of time, because of oxidation and vaporization of the electrode material during welding. The materials of non-consumable electrodes are usually copper coated carbon or graphite, pure tungsten, thoriated or zirconiated tungsten.

5. Hand Screen

Hand screen used for protection of eyes and supervision of weld bead.

6. Chipping hammer

Chipping Hammer is used to remove the slag by striking.

7. Wire brush

Wire brush is used to clean the surface to be weld.

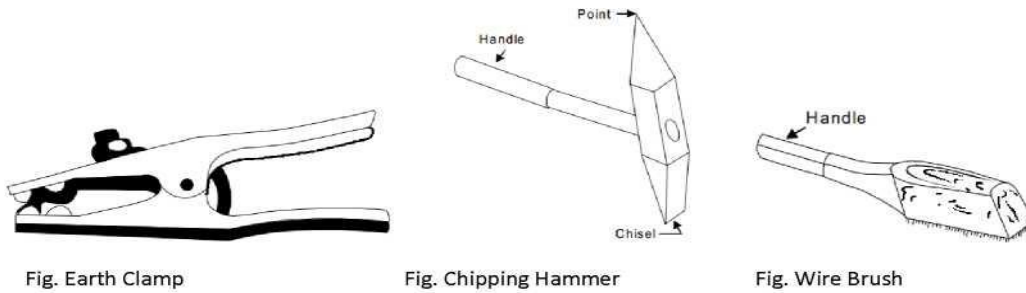

Fig. 8 Earth Clamp, Chipping Hammer, Wire Brush

8. Protective clothing

Operator wears the protective clothing such as apron to keep away the exposure of direct heat to the body.

Safety Recommendations for ARC Welding

The beginner in the field of arc welding must go through and become familiar with these general safety recommendations which are given as under.

1. The body or the frame of the welding machine shall be efficiently earthed. Pipe lines containing gases or inflammable liquids or conduits carrying electrical conductors shall not be used for a ground return circuit. All earth connections shall be mechanically strong and electrically adequate for the required current.
2. Welding arc in addition to being very hot is a source of infra-red and ultra-violet light also; consequently the operator must use either helmet or a hand-shield fitted with a special filter glass to protect eyes.
3. Excess ultra-violet light can cause an effect similar to sunburn on the skin of the welder.
4. The welder's body and clothing are protected from radiation and burns caused by sparks and flying globules of molten metal with the help of the following:
 5. Gloves protect the hands of a welder.
 6. Leather or asbestos apron is very useful to protect welder's clothes and his trunk and thighs while seated he is doing welding.
 7. For overhead welding, some form of protection for the head is required.
 8. Leather skull cap or peaked cap will do the needful.
 9. Leather jackets and leather leggings are also available as clothes for body protection.
10. Welding equipment shall be inspected periodically and maintained in safe working order at all Times.
11. Arc welding machines should be of suitable quality.
12. All parts of welding set shall be suitably enclosed and protected to meet the usual service Conditions.

EXPERIMENT – 1

BUTT JOINT

Aim: To make a Butt joint using the given two M.S pieces by arc welding.

Material Required:

Mild steel plate of size 100X50X5 mm - 2 No's

Welding Electrodes: M.S electrodes 3.1 mm X350 mm

Welding Equipment: Air cooled transformer

Voltage-80 to 600 V 3 phase supply, amps up to 350

Tools and Accessories required:

1. Rough and smooth files.
2. Protractor
3. Arc welding machine (transformer type)
4. Mild steel electrode and electrode holder
5. Ground clamp
6. Tongs
7. Face shield
8. Apron
9. Chipping hammer.

Sequence of operations:

1. Marking
2. Cutting
3. Edge preparation (Removal of rust, scale etc.) by filing
4. Try square leveling
5. Tacking
6. Welding
7. Cooling
8. Chipping
9. Cleaning

Procedure:

1. The given M.S pieces are thoroughly cleaned of rust and scale.
2. One edge of each piece is beveled, to an angle of 30° , leaving nearly $\frac{1}{4}$ of the flat thickness, at one end.
3. The two pieces are positioned on the welding table such that, they are separated slightly for better penetration of the weld.
4. The electrode is fitted in the electrode holder and the welding current is set to be a proper value.
5. The ground clamp is fastened to the welding table.
6. Wearing the apron and using the face shield, the arc is struck and holding the two pieces together; first run of the weld is done to fill the root gap.
7. Second run of the weld is done with proper weaving and with uniform movement. During the process of welding, the electrode is kept at 15° to 25° from vertical and in the direction of welding.
8. The scale formation on the welds is removed by using the chipping hammer. Filing is done to remove any spatter around the weld.

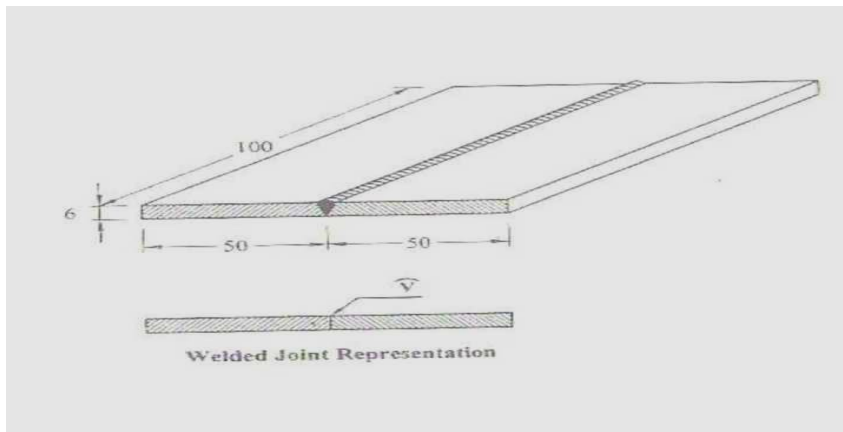

Butt Joint

Result

The single V-butt joint is thus made, using the tools and equipment as mentioned above.

EXPERIMENT – 2

LAP JOINT

Aim: To make a Lap joint, using the given two M.S pieces and by arc welding.

Material Supplied:

Mild steel plate of size 100X50X5 mm - 2 No's

Welding Electrodes: M.S electrodes 3.1 mm X350 mm

Welding Equipment: Air cooled transformer

Voltage-80 to 600 V, 3- ϕ supply, Current up to 350Amps

Tools and Accessories required:

1. Rough and smooth files.
2. Protractor
3. Arc welding machine (transformer type)
4. Mild steel electrode and electrode holder
5. Ground clamp
6. Tongs
7. Face shield
8. Apron
9. Chipping hammer.

Sequence of operations:

1. Marking
2. Cutting
3. Edge preparation (Removal of rust, scale etc.) by filing
4. Try square leveling
5. Tacking
6. Welding
7. Cooling
8. Chipping
9. Cleaning

Procedure:

1. The given M.S pieces are thoroughly cleaned of rust and scale.
2. The two pieces are positioned on the welding table such that, the two pieces overlapped one over the other as shown in drawing.
3. The electrode is fitted in the electrode holder and the welding current is set to be a proper value.
4. The ground clamp is fastened to the welding table.
5. Wearing the apron and using the face shield, the arc is struck and the work pieces are tack-welded at both the ends and at the centre of the joint.
6. The alignment of the lap joint is checked and the tack-welded pieces are required.
7. The scale formation on the welds is removed by using the chipping hammer.
8. Filing is done to remove any spatter around the weld.

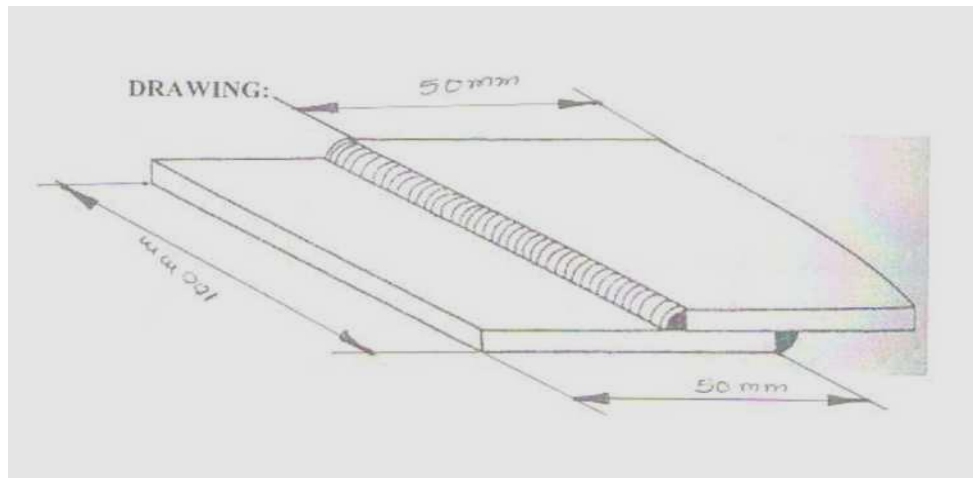

Lap Joint

RESULT

Thus lap joint is made using the given tools .

EXPERIMENT – 3

CORNER JOINT

Aim: To make a corner joint, using the given two M.S pieces and by arc welding.

Material Supplied:

Mild steel plate of size 100X50X5 mm - 2 No's

Welding Electrodes: M.S electrodes 3.1 mm X350 mm

Welding Equipment: Air cooled transformer

Voltage-80 to 600 V 3 phase supply, amps up to 350

Tools and Accessories required:

1. Rough and smooth files.
2. Protractor
3. Arc welding machine (transformer type)
4. Mild steel electrode and electrode holder
5. Ground clamp
6. Tongs
7. Face shield
8. Apron
9. Chipping hammer.

Sequence of operations:

1. Marking
2. Cutting
3. Edge preparation (Removal of rust, scale etc.) by filing
4. Try square leveling
5. Tacking
6. Welding
7. Cooling
8. Chipping
9. Cleaning

Procedure:

1. The given M.S pieces are thoroughly cleaned of rust and scale.
2. The two pieces are positioned on the welding table such that, the L shape is formed. The tongs are made use of for the purpose.
3. The electrode is fitted in the electrode holder and the welding current is set to be a proper value.
4. The ground clamp is fastened to the welding table.
5. Wearing the apron and using the face shield, the arc is struck and the work pieces are tack-welded at both the ends and at the centre of the joint.
6. The alignment of the corner joint is checked and the tack-welded pieces are required.
7. The scale formation on the welds is removed by using the chipping hammer.
8. Filing is done to remove any spatter around the weld.

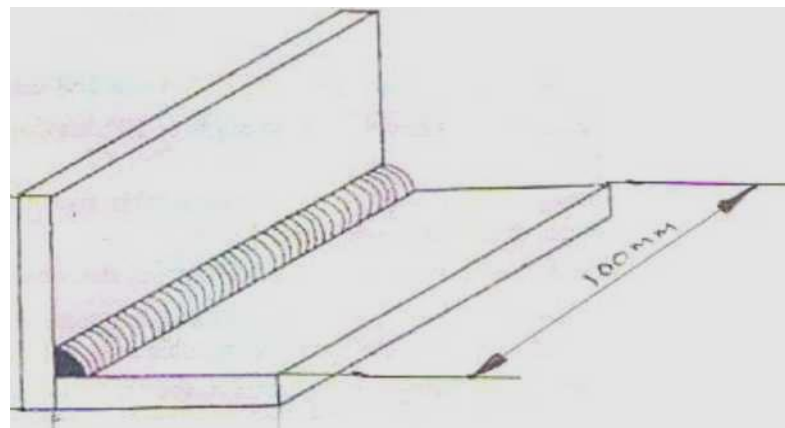
**Fig 1 Corner Joint**

Result: The corner joint is thus made, using the tools and equipment as mentioned

HOUSE WIRING

Introduction:

Power is supplied to domestic installations through a phase and a neutral, forming a single phase. A.C 230V, 2- wire system for industrial establishments. Power is supplied through three phase four wire system to give 440V. Fig 1 shows the power tapping for domestic and industrial purposes. The neutral is earthed at the distribution sub-station of the supply.

When supplied to domestic utilizes power is fed to a kilowatt meter and then to a distribution panel. The panel distributes power along several circuits' breakers. The panel also serves as a main switch.

Electrical wiring is defined as a system of electrical conductors, components and apparatus for conveying electrical power from the source to the point of use. The wiring system must be designed to provide a constant voltage to the load.

Elements of house wiring:

Fuses & circuit Breakers:

These are the devices to provide protection to a circuit against excess current. Open link fuses are not in safe in operations, even though they are cheaper and reliable. It consists of a thin strip of metal (or) wire.

Electric switch:

This is a device that makes and breaks or changes the course of electric circuit. It consists of 2 or more contacts mounted on an insulating structure and arranged such that they may be moved in to and out of contact with each other by a suitable operating mechanism.

Plug:

It is a device carrying 2 or 3 contact, designed for engagement with corresponding plugs pins and arranged for connection to fixed wiring and arranged for attachment to appliances such as radio, T.V, table, fan etc.,

Socket outlet:

It is a device carrying 2 or 3 contacts, designed for engagement with corresponding plug pins and arranged for connection to fixing wiring.

Lamp holder:

These are designed to hold lamps & connect them in the circuit. Both bay one cap and screw lamp holders are available up to 200 watts lamps.

Ceiling rose:

A ceiling rose consists of a circular base & cover made of Bakelite. The base has 2 or 3 terminal plates. One end of the plate is connected to supply wire connected to pendent lamp, ceiling fan, exhaust fan, etc.

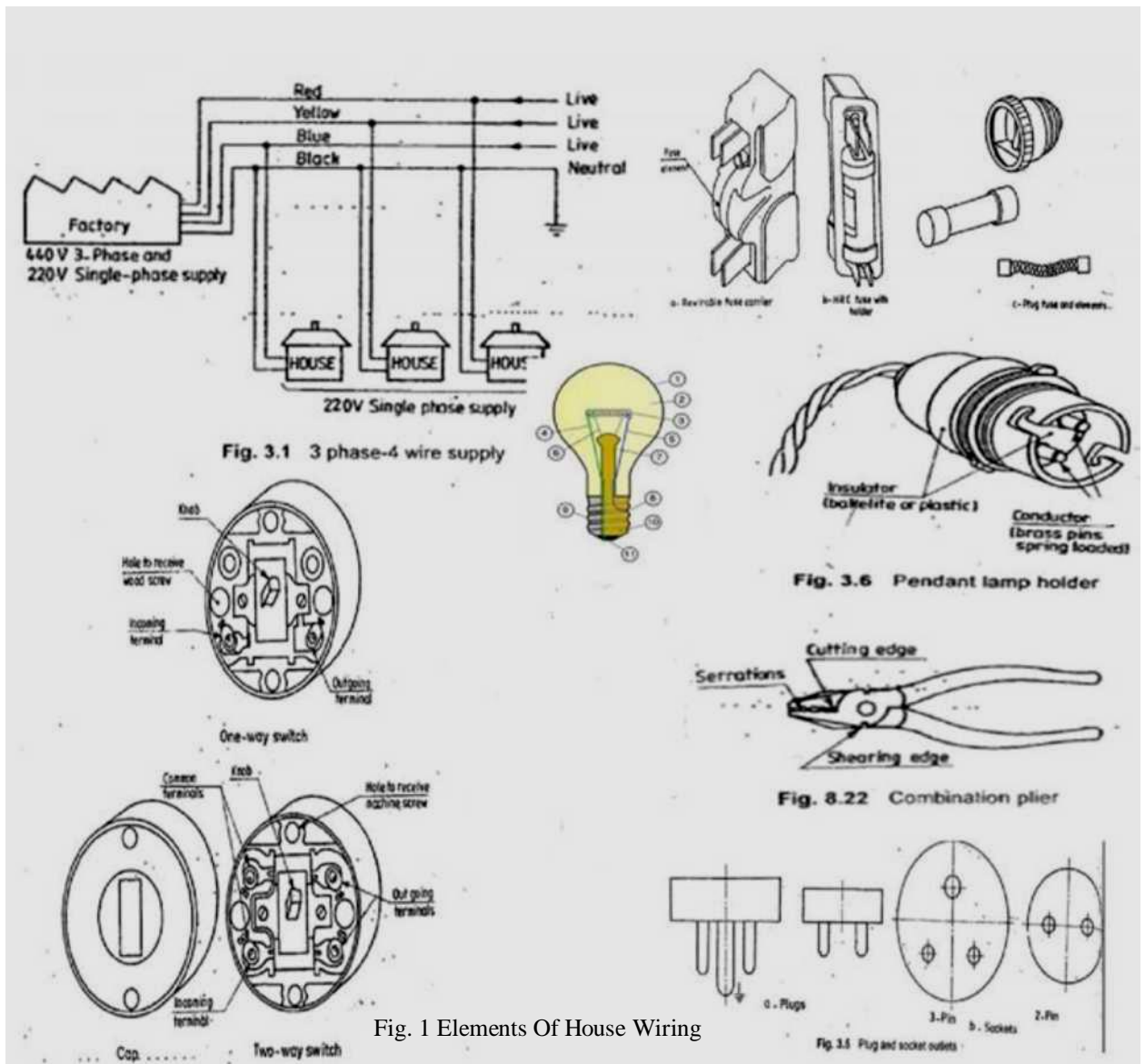

Fig. 1 Elements Of House Wiring

NOTE: Parts of bulb

- 1) Glass bulb
- 2) Low-pressure inert gas
- 3) Tungsten- filament
- 4) Contact wire (out of stem)
- 5) Contact wire (into stem)
- 6) Support wires
- 7) Stem
- 8) Contact wire (out of stem)
- 9) Cap (Screw)
- 10) Insulation
- 11) Electrical contact

Main switch:

This is a switch intended to connect or cut-off the supply of electrical to the whole of an installation. It is generally of metal clad type. The metal clad gives greater strength and safety. The main switch contains one or more fuses, single phase, and A.C. circuits.

Incandescent light:

Incandescent means ‘glowing at white heat’. A lamp actually works like heating elements that it gives off light by becoming white hot, the amount of power it consume is stamped on the bulb. Higher the wattage, brighter the light. The bulbs have filaments made of tungsten.

Interior wiring :**Wires & wire sizes :**

A wire is defined as a bare or insulated conductor consisting of one (or) several strands. An insulating wire consists of a conductor with insulating material made of Vulcanized Indian Rubber (VIR) (or) Poly Vinyl Chloride (PVC). The wire may consist of 1 or several twisted strands. A multi core conductor consists of several cores insulated from one another and enclosed in a common sheathing. Wire sizes are specified by the diameter of the wire, using a standard wire gauge (SWG), which also gives an idea of the current carrying capacity. The specification consists of the both the number of strands and the diameter of the each wire in it.

EXPERIMENT – 1

ONE LAMP CONTROLLED BY TWO TWO-WAY SWITCHES (STAIR CASE CONNECTION)

Aim: - to give connections to one lamp controlled by two two-way switches.

Tools required: -

- 1.Screw driver
- 2.Cutting pliers
- 3.Ball peen hammer
- 4.Insulation remover
- 5.Tester

Materialrequired: -

- 1.Wooden wiring board
- 2.Silk wire
- 3.Electrical bulb - 1 No
- 4.Two -way switches - 2Nos
- 5.Wooden round block - 1 No
- 6.Batten lamp holder - 1 No
- 7.Wire clips
- 8.Nails
- 9.Screws

PROCEDURE:-

- The outline of the wiring diagram is marked on the wooden wiring board.
- Clips are nailed to the board, following the wiring diagram.
- Wires are stretched and clamped with the clips.
- Round blocks are screwed on to the board, as per the diagram.
- Wires are connected to the holders and the switch, which are then screwed on to the round blocks.
- Bulb is fitted to the holder.
- The wiring connections are tested, by giving power supply.

Safety precautions: -

- Electricity has no respect for ignorance. Do not apply voltage or turn-on any device until it has been properly checked.
- Care should be taken from electrical shocks.
- Don't touch the connection points.
- Avoid loose connection.
- Don't work at damped areas and with wet clothing.
- Handle the lamp carefully.

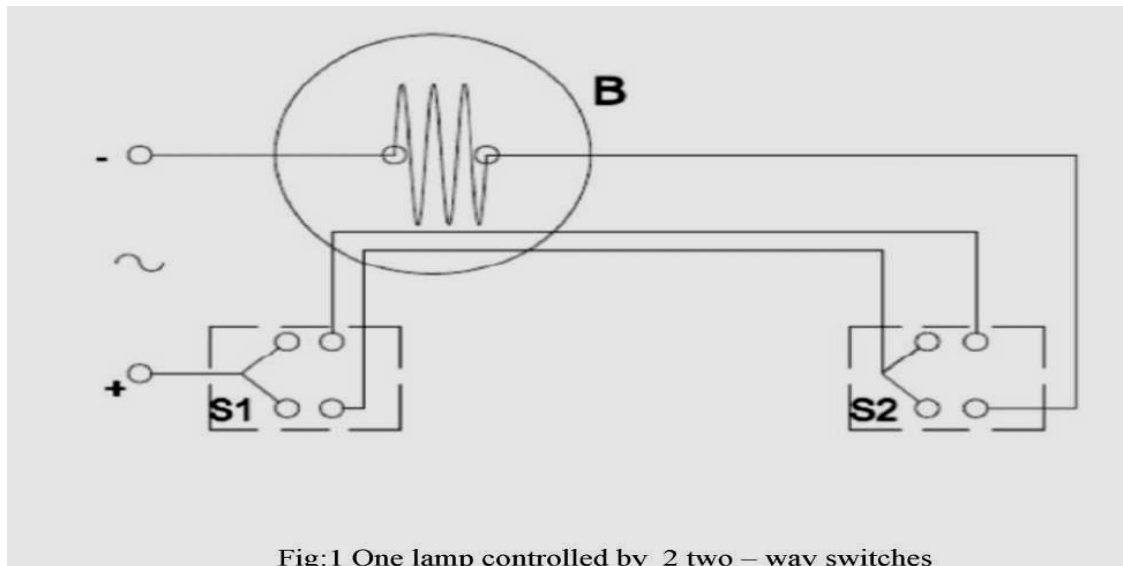

Result: - Connections are given to one lamp controlled by two two-way switches and tested.

EXPERIMENT – 2

Wiring For Two Lamps (Bulbs) With Independent Switch Controls

With or Without Looping

Aim: - To give connection to two lights, controlled With Independent Switch Controls with or Without Looping.

Tools required: -

- 1.Screw driver
- 2.Cutting pliers
- 3.Ball peen hammer
- 4.Insulation remover
- 5.Tester

Materialrequired: -

- 1.Wooden wiring board
- 2.Silk wire
- 3.Electrical bulbs - 2 No
- 4.One-way switch - 1No
- 5.Wooden round blocks - 1 No
- 6.Batten lamp holders - 1 No
- 7.Wire clips
- 8.Nails
- 9.Screws

PROCEDURE:-

- The outline of the wiring diagram is marked on the wooden wiring board.
- Clips are nailed to the board, following the wiring diagram.
- Wires are stretched and clamped with the clips.
- Round blocks are screwed on to the board, as per the diagram.
- Wires are connected to the holders and the switch, which are then screwed on to the round blocks.
- Bulb is fitted to the holder.

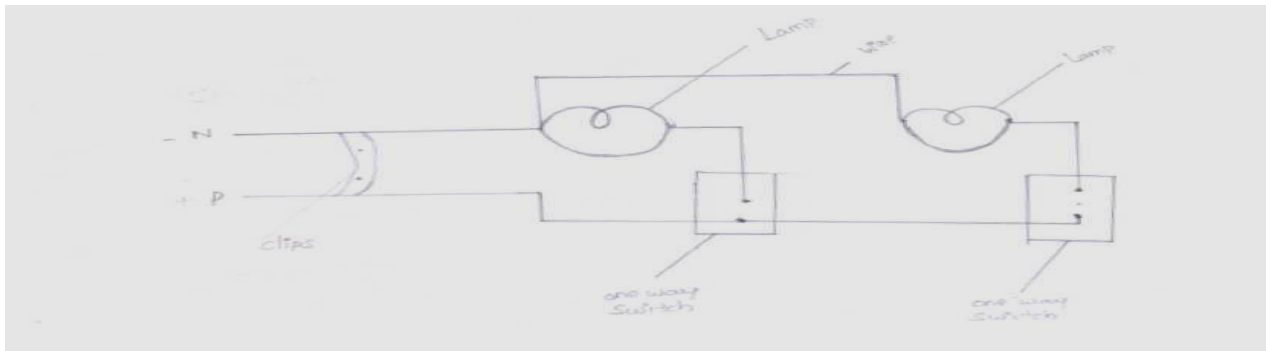

Two lights controlled by two independent switches

- The wiring connections are tested, by giving power supply

Safety precautions: -

Electricity has no respect for ignorance. Do not apply voltage or turn-on any device until it has been properly checked.

- I. Care should be taken from electrical shocks.
- II. Don't touch the connection points.
- III. Avoid loose connection.
- IV. Don't work at damped areas and with wet clothing.
- V. Handle the lamp carefully.

Result: - Connections are given to two bulbs controlled by the two independent switches and Tested.

PLUMBING

Plumbing is a skilled trade of working with pipes or tubes and plumbing fixtures. The process is mainly used for the supply of drinking water and the drainage of waste water, sometimes mixed with waste floating materials in a living or working place. A plumber is someone who installs or repairs piping systems, plumbing fixtures and equipment such as valves, washbasins, water heaters, water closets, etc. Thus it usually refers to a system of pipes and fixtures installed in a building for the distribution of water and the removal of waterborne wastes.

The Latin word plum bum, means metal lead pipe, is the origin for developing the term plumbing. Plumbing process was originated during the ancient civilizations such as the greek, Roman, Persian, Indian and Chinese civilizations as they developed public baths and needed to provide potable water, and drainage of wastes carried by water.

PIPES AND THEIR JOINTS:

Pipes are manufactured by using different types of materials like steel, cast iron, galvanized iron, brass, copper, aluminum, lead, plastic, concrete, asbestos, etc. They are usually classified according to the material. They are also grouped as cast, welded, seamless, extruded, etc. For conveying large quantity of water, cast iron, steel or concrete pipes having large diameter are usually used. Galvanized iron pipes (GI pipes) are popular for medium and low pressure water supply lines.

Plastic pipes are preferred for household uses at low pressure. Pipes are generally specified by their inner diameter (Nominal diameter specified in inches). Hence, the pipe fitting size is also based on this dimension. But for plastic pipes, this rule is not strictly followed because threading is not usually required for them. For engineering uses, along with the nominal diameter, the pipe thickness is also specified as light, medium or heavy.

Types of pipe joints:

According to the pipe material, size and application, different methods are used to join pipes. The most common types of pipe joints are:

1. Screwed pipe joint - For GI Pipes
2. Welded pipe joint - for steel, copper, aluminum and lead pipes
3. Flanged pipe joint - for cast iron and steel pipes
4. Soldered pipe joint - for brass and copper tubes
5. Glued or cemented pipe joint - for PVC pipes

Pipes made of iron (GI Pipes) and brass of small and medium diameters (10 mm to 100 mm) are usually joined by screwing the pipe specials with internal or external threads. Welding is used to make permanent joint of medium and large diameter steel pipes. Flanged pipe joints are common in medium and large diameter pipes of cast iron and steel, along with rubber/CAF (Compressed asbestos fibre) gaskets. The flanged are screwed to the pipe for smaller diameter but made integral for large diameters. Pipes of copper and brass are usually joined by soldering.

PVC (poly Vinyl Chloride) pipe is the most popular choice in plastic group. It is rigid and uses thread and solvent weld (glue) connections. It also can be heat fused. PVC pipes are available in various pressure ratings for water supply, and are a very choice for landscape irrigation. The reasons for the popularity are the economy, no corrosion and easiness to work. CPVC is a different type of

plastic, which has an extra chlorine atom in the compound, can be used for the hot water supply, and in industry.

To join plastic pipes, gluing or cementing method is used. Solvent cement is the gluing material and it partially melts the surface of the plastic pipe to make the joint. As the glue evaporates within two minutes, a strong joint is obtained.

Screwed pipe fittings, (pipe specials) are removable or temporary pipe connections which permit necessary dismantling or reassembly for the purpose of installation, maintenance, cleaning, repair, etc.

The functions of pipe fittings can be broadly classified as:

1. To join two or more pipe lines together
2. To effect change in diameter or direction
3. To close the end of a pipe line

The most common types of screwed pipe fittings used in galvanized iron (GI) pipe lines and plastic (PVC) pipe lines are shown in Figure 1 (I to 17). A brief description of these fittings is given below

1. **Coupler (coupling):** Two pipe lines of equal diameter and in axial alignment can be joined by a coupler (coupling). It is a short sleeve with internal thread.

2. **Reducer coupler (Reducer coupling):** This is a coupler to join two pipe lines of different diameters in axial alignment.

3. **90° Elbow:** This is a pipe special used or effecting abrupt change in direction through 90°. Internal threads are provided on both ends. An elbow brings twice the head loss than a bend.

4. **90° Reducer elbow:** This is an elbow with outlet diameter less than that of inlet diameter It is used to join two pipe lines having different diameters and meeting at right angle.

5. **Bend:** This is a pipe special used to effect gradual change in direction (usually 90°).The two ends of the bend are externally threaded.

6. **Return hand:** This bend is used to return the direction of pipe line through 180°.The ends are internally threaded for fitting the pipe lines.

7. **Tee:** This pipe special is used to make a branch connection of same diameter to the main pipe line at right angle. A Tee is internally threaded and it connects three ends of pipes.

a) Reducer Tee: This is a pipe special similar to Tee used to take a branch connection of reduced diameter from the main pipe line.

b) Cross: This pipe special is used to take two branch connections at right angles to the main pipe line. The threads are provided internally.

8. **Close nipple:** A nipple is a short straight piece of pipe with external thread on both ends. A close nipple is the shortest one of this category with external thread for the full length. They are used to join two internally threaded pipe specials and valves.

9. **Short nipple:** A short nipple has the same shape and function of a close nipple, but it has a short unthreaded portion at the middle of its length for gripping.

10. **Short nipple with hexagonal grip:** This nipple has an additional hexagonal nut shape at the middle portion for easy screwing with spanner. It is similar to an ordinary short nipple, except that difference.

11. **Hose nipple:** A hose nipple is used to connect a hose (flexible pipe-usually plastic or rubber) to a pipe line. One end of the hose-nipple has a stepped taper to fit the hose, while other end has thread. A hexagonal nut shape is given to the middle portion for gripping with a spanner.

12. **Male plug:** A male plug is used to close an internally threaded end of a pipe line or pipe special. It has external thread and a grip of square shape at the end.

13. **Female plug (cap):** A female plug is used to close an externally thread end of a pipe or pipe special. It has internal thread and a grip of square shape at the end.

14. **Screwed union:** It consists of three pieces as shown in the drawing. The two end pieces have internal threads at their ends which are connected to the pipe ends. The central hexagonal (or octagonal) piece (union nut) has internal thread at one end and a collar at the other end. After the end pieces are screwed on to the pipes, the central piece (union nut) is tightened to draw the end pieces together to get a water tight joint.

15. **Flange:** This is a disc type pipe special having threaded hole at the centre for screwing to the externally threaded end of a pipe line. It will have holes around the central hole at equal angular spacing (3, 4, 6 or 8 Nos.) for joining to another similar flange or flat surface using bolt or stud. Example for the use of various pipe fittings in pipe line is given in Figure 1.

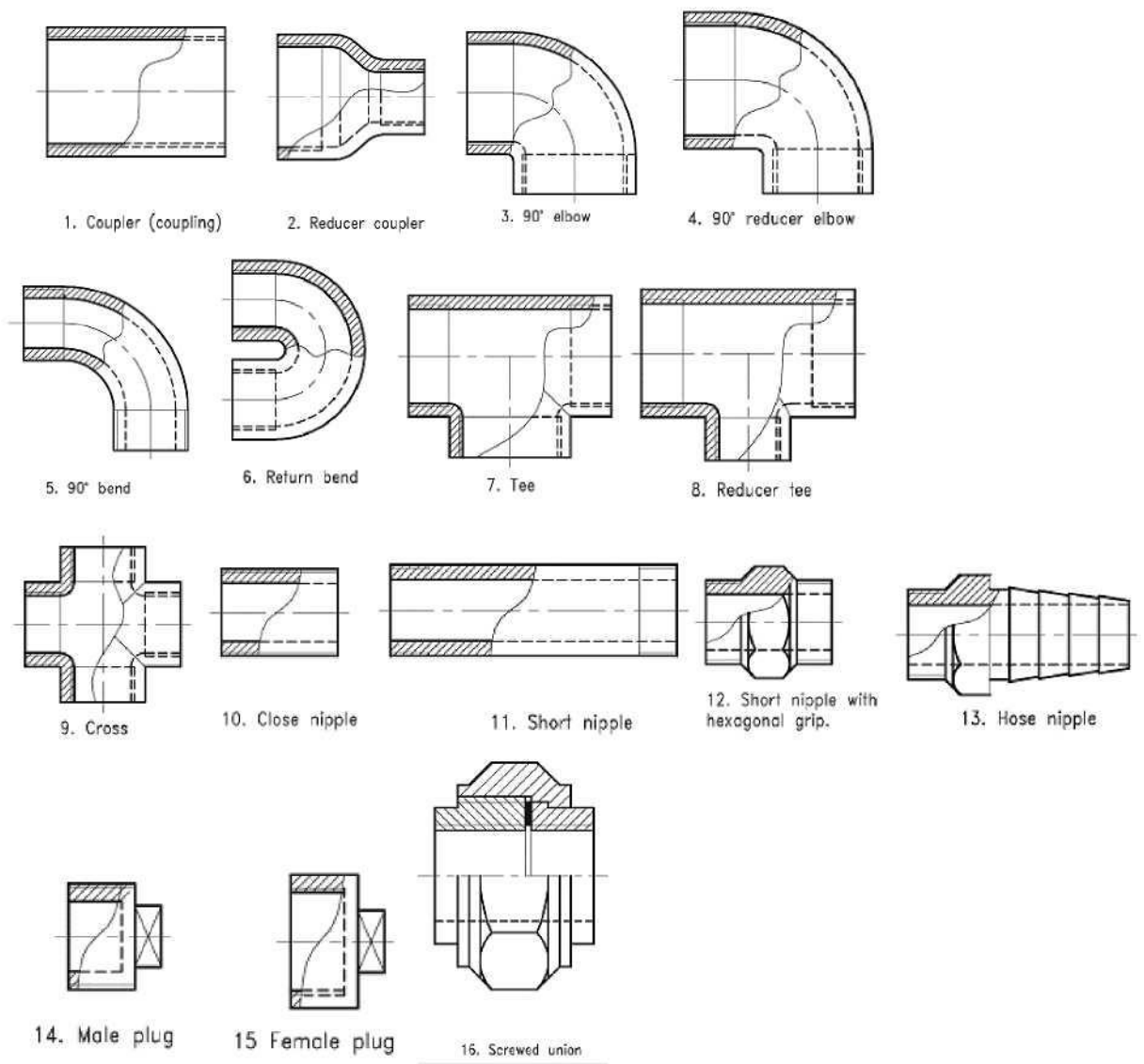

Fig .1 Types of Pipe Fittings

POWER TOOLS

INTRODUCTION:

Power tool is a powered by an electric motor, a compressed air motor, or a gasoline engine. Power tools are classified as either stationary or portable, where portable means handheld. They are used in industry, in construction, and around the house for cutting, shaping, drilling, sanding, painting, grinding, and polishing. Stationary power tools for metalworking are usually called Machine tools.

The lathe is the oldest power tool, being known to the ancient Egyptians. Early industrial revolution-era factories had batteries of power tools driven by belts from overhead shafts. The prime power source was a water wheel or a steam engine. Stationary power tools are prized not only for their speed, but for their accuracy. A table saw not only cuts faster than a hand saw, but the cuts are smoother, straighter and more square than even the most skilled man can do with a handsaw. Lathes produce truly round objects that cannot be made in any other way.

An electric motor is the universal choice to power stationary tools. Portable electric tools may be either corded or battery-powered. Common power tools include the drill, various types of saws, the router, the electric sander, and the lathe.

The term power tool is also used in a more general sense, meaning a technique for greatly simplifying a complex or difficult task.

1. POWER HACKSAW:

A power hacksaw is a type of hacksaw that is powered either by its own electric motor (also known as electric hacksaw) or connected to a stationary engine. Most power hacksaw are stationary machines but some portable models do exist. Stationary models usually have a mechanism to lift up the saw blade on the return stroke and some have a coolant pump to prevent the saw blade from overheating.

While stationary electric hacksaw are reasonably uncommon they are still produced but saws powered by a stationary engines have gone out of fashion. The reason for using one is that they provide a cleaner cut than an angle grinder or other types of saw.

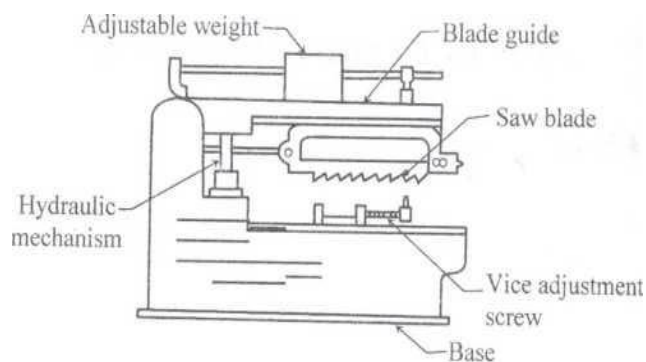

Fig. Power Hacksaw

Fig .1 Power Hack Saw

Hand-Held circular saws:

The term circular saw is most commonly used to refer to a hand-held electric circular saw designed for cutting wood, which may be used less optimally for cutting other materials with the exchange of specific blades. Circular saws can be either left or right handed, depending on the side of the blade where the motor sits and which hand the operator uses when holding a saw.

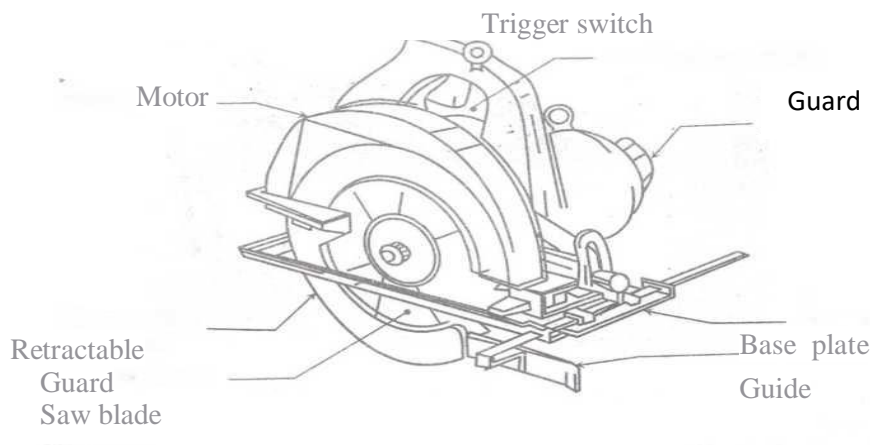

Fig 2 Circular saw (Portable)

DRILL:

A drill is a tool with a rotating drill bit used for drilling holes in various materials. Drills are commonly used in woodworking, metalworking. Special designed drills are also used in medical and other applications such as in space missions.

The drill bit is gripped by a chuck at one end of the drill and rotated while pressed against the target material. The tip of the drill bit does the work of cutting into the target material, either slicing off thin shavings (twist drills or auger bits), grinding of small particles (oil drilling), or crushing and removing pieces of the work piece (masonry drill).

During the operation, chips that are produced within the work piece must exit through the flutes to the outside of the tool. As the chip is formed and extracted towards the surface, it will generate friction. Friction subsequently heat is also generated when the drill bit touch the work piece during the hole making process. Therefore, chip disposal and cutting fluids are among the most important elements need to be consider during this process.

Normally, holes produced by drilling are bigger than the drill diameter and depending on its applications; the drilled holes will subjected to other operations such as reaming or honing to better surface finish and dimensional accuracy.

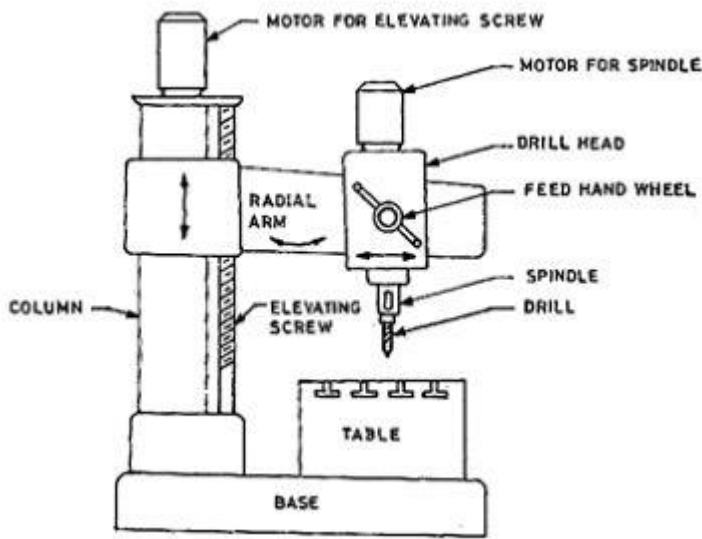

Fig. 3 Drilling Machine

BENCH GRINDER:

A bench grinder or pedestal grinder is a machine used to drive an abrasive wheel (or wheels).

Depending on the grade of the grinding wheel it may be used for sharpening cutting tools such as lathe tools or drill bits. Alternatively it may be used to roughly shape metal prior to welding or fitting.

A wire brush wheel or buffing wheel can be interchanged with the grinding wheels in order to clean or polish work-pieces.

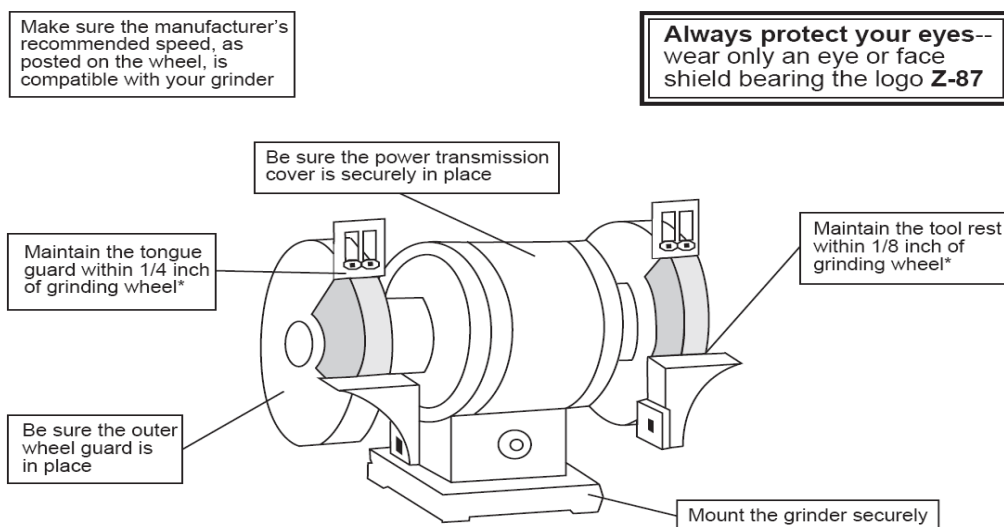

Fig. 4 Bench grinder

Use of bench Grinders:

- Use properly dressed and trued grinding or cutting wheels only.
- Keep both hands firmly on the grinder during any operation.
- Be sure the cutting or grinding wheel is clear of the work before starting or stopping the grinder.
- Use the grinder only when you have good footing and are in a balanced position.
- Always check to be certain that you and others near a grinder are wearing suitable eye and face protection.
- Make sure the grinder is properly grounded and the power cord is in good condition.
- Unplug the grinder before changing grinding or cutting wheels.
- Always check to see that the cord is clear of the grinding wheel.
- Do not lay a hand-held grinder down until the grinding wheel stops turning.